

AOD609

Complementary Enhancement Mode Field Effect Transistor

General Description

The AOD609 uses advanced trench technology MOSFETs to provide excellent $R_{DS(ON)}$ and low gate charge. The complementary MOSFETs may be used in H-bridge, Inverters and other applications.

- RoHS Compliant
- Halogen Free*

Features

n-channel

V_{DS} (V) = 40V, I_D = 12A ($V_{GS}=10V$)
 $R_{DS(ON)} < 30m\Omega$ ($V_{GS}=10V$)
 $R_{DS(ON)} < 40m\Omega$ ($V_{GS}=4.5V$)

p-channel

V_{DS} (V) = -40V, I_D = -12A ($V_{GS}=-10V$)
 $R_{DS(ON)} < 45m\Omega$ ($V_{GS}= -10V$)
 $R_{DS(ON)} < 66m\Omega$ ($V_{GS}= -4.5V$)

100% UIS Tested!
100% Rg Tested!

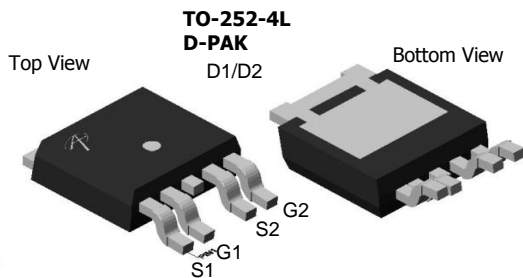

Top View
 Drain Connected to Tab

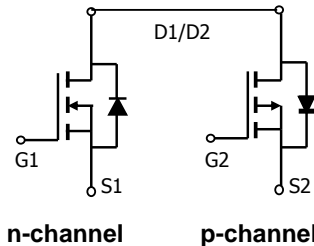

Absolute Maximum Ratings $T_A=25^\circ\text{C}$ unless otherwise noted

Parameter	Symbol	Max n-channel	Max p-channel	Units
Drain-Source Voltage	V_{DS}	40	-40	V
Gate-Source Voltage	V_{GS}	± 20	± 20	V
Continuous Drain Current ^{B,H}	I_D	$T_C=25^\circ\text{C}$	-12	A
		$T_C=100^\circ\text{C}$	12	
Pulsed Drain Current ^B	I_{DM}	30	-30	
Avalanche Current ^C	I_{AR}	14	-20	
Repetitive avalanche energy $L=0.1\text{mH}$ ^C	E_{AR}	9.8	20	mJ
Power Dissipation	P_D	$T_C=25^\circ\text{C}$	30	W
		$T_C=100^\circ\text{C}$	15	
Power Dissipation	P_{DSM}	$T_A=25^\circ\text{C}$	2	W
		$T_A=70^\circ\text{C}$	1.3	
Junction and Storage Temperature Range	T_J, T_{STG}	-55 to 175	-55 to 175	$^\circ\text{C}$

Thermal Characteristics: n-channel and p-channel

Parameter	Symbol	Device	Typ	Max	Units
Maximum Junction-to-Ambient ^{A,D}	$R_{\theta JA}$	n-ch	$t \leq 10\text{s}$	17.4	25
Maximum Junction-to-Ambient ^{A,D}			Steady-State	50	60
Maximum Junction-to-Lead ^C	$R_{\theta JC}$	n-ch	4	5.5	$^\circ\text{C/W}$
Maximum Junction-to-Ambient ^{A,D}	$R_{\theta JA}$	p-ch	$t \leq 10\text{s}$	16.7	25
Maximum Junction-to-Ambient ^{A,D}			Steady-State	50	60
Maximum Junction-to-Lead ^C	$R_{\theta JC}$	p-ch	3.5	5	$^\circ\text{C/W}$

N Channel Electrical Characteristics ($T_J=25^\circ\text{C}$ unless otherwise noted)

Symbol	Parameter	Conditions	Min	Typ	Max	Units
STATIC PARAMETERS						
BV_{DSS}	Drain-Source Breakdown Voltage	$I_D=250\mu\text{A}$, $V_{GS}=0\text{V}$	40			V
I_{DSS}	Zero Gate Voltage Drain Current	$V_{DS}=40\text{V}$, $V_{GS}=0\text{V}$ $T_J=55^\circ\text{C}$			1 5	μA
I_{GSS}	Gate-Body leakage current	$V_{DS}=0\text{V}$, $V_{GS}=\pm 20\text{V}$			± 100	nA
$V_{GS(th)}$	Gate Threshold Voltage	$V_{DS}=V_{GS}$, $I_D=250\mu\text{A}$	1.7	2.5	3	V
$I_{D(ON)}$	On state drain current	$V_{GS}=10\text{V}$, $V_{DS}=5\text{V}$	30			A
$R_{DS(ON)}$	Static Drain-Source On-Resistance	$V_{GS}=10\text{V}$, $I_D=12\text{A}$ $T_J=125^\circ\text{C}$		24 37	30 46	m Ω
		$V_{GS}=4.5\text{V}$, $I_D=8\text{A}$		31	40	
g_{FS}	Forward Transconductance	$V_{DS}=5\text{V}$, $I_D=12\text{A}$		25		S
V_{SD}	Diode Forward Voltage	$I_S=1\text{A}$, $V_{GS}=0\text{V}$		0.76	1	V
I_S	Maximum Body-Diode Continuous Current ^H				12	A
DYNAMIC PARAMETERS						
C_{iss}	Input Capacitance	$V_{GS}=0\text{V}$, $V_{DS}=20\text{V}$, $f=1\text{MHz}$		516	650	pF
C_{oss}	Output Capacitance			82		pF
C_{riss}	Reverse Transfer Capacitance			43		pF
R_g	Gate resistance	$V_{GS}=0\text{V}$, $V_{DS}=0\text{V}$, $f=1\text{MHz}$		4.6	6.9	Ω
SWITCHING PARAMETERS						
$Q_g(10\text{V})$	Total Gate Charge	$V_{GS}=10\text{V}$, $V_{DS}=20\text{V}$, $I_D=12\text{A}$		8.3	10.8	nC
Q_{gs}	Gate Source Charge			2.3		nC
Q_{gd}	Gate Drain Charge			1.6		nC
$t_{D(on)}$	Turn-On Delay Time	$V_{GS}=10\text{V}$, $V_{DS}=20\text{V}$, $R_L=1.4\Omega$, $R_{GEN}=3\Omega$		6.4		ns
t_r	Turn-On Rise Time			3.6		ns
$t_{D(off)}$	Turn-Off Delay Time			16.2		ns
t_f	Turn-Off Fall Time			6.6		ns
t_{rr}	Body Diode Reverse Recovery Time	$I_F=12\text{A}$, $dI/dt=100\text{A}/\mu\text{s}$		18	24	ns
Q_{rr}	Body Diode Reverse Recovery Charge	$I_F=12\text{A}$, $dI/dt=100\text{A}/\mu\text{s}$		10		nC

A: The value of $R_{\theta JA}$ is measured with the device in a still air environment with $T_A=25^\circ\text{C}$. The power dissipation P_{DSM} and current rating I_{DSM} are based on $T_{J(MAX)}=150^\circ\text{C}$, using the steady state junction-to-ambient thermal resistance.

B: The power dissipation P_D is based on $T_{J(MAX)}=175^\circ\text{C}$, using junction-to-case thermal resistance, and is more useful in setting the upper dissipation limit for cases where additional heatsinking is used.

C: Repetitive rating, pulse width limited by junction temperature $T_{J(MAX)}=175^\circ\text{C}$.

D: The $R_{\theta JA}$ is the sum of the thermal impedance from junction to case $R_{\theta JC}$ and case to ambient.

E: The static characteristics in Figures 1 to 6 are obtained using $<300\mu\text{s}$ pulses, duty cycle 0.5% max.

F: These curves are based on the junction-to-case thermal impedance which is measured with the device mounted to a large heatsink, assuming a maximum junction temperature of $T_{J(MAX)}=175^\circ\text{C}$. The SOA curve provides a single pulse rating.

G: These tests are performed with the device mounted on 1 in² FR-4 board with 2oz. Copper, in a still air environment with $T_A=25^\circ\text{C}$.

H: The maximum current rating is limited by bond-wires.

THIS PRODUCT HAS BEEN DESIGNED AND QUALIFIED FOR THE CONSUMER MARKET. APPLICATIONS OR USES AS CRITICAL COMPONENTS IN LIFE SUPPORT DEVICES OR SYSTEMS ARE NOT AUTHORIZED. AOS DOES NOT ASSUME ANY LIABILITY ARISING OUT OF SUCH APPLICATIONS OR USES OF ITS PRODUCTS. AOS RESERVES THE RIGHT TO IMPROVE PRODUCT DESIGN, FUNCTIONS AND RELIABILITY WITHOUT NOTICE.

P-Channel Electrical Characteristics ($T_J=25^\circ\text{C}$ unless otherwise noted)

Symbol	Parameter	Conditions	Min	Typ	Max	Units
STATIC PARAMETERS						
BV_{DSS}	Drain-Source Breakdown Voltage	$I_D = -250\mu\text{A}$, $V_{GS} = 0\text{V}$	-40			V
I_{DSS}	Zero Gate Voltage Drain Current	$V_{DS} = -40\text{V}$, $V_{GS} = 0\text{V}$ $T_J = 55^\circ\text{C}$			-1 -5	μA
I_{GSS}	Gate-Body leakage current	$V_{DS} = 0\text{V}$, $V_{GS} = \pm 20\text{V}$			± 100	nA
$V_{GS(th)}$	Gate Threshold Voltage	$V_{DS} = V_{GS}$, $I_D = -250\mu\text{A}$	-1.7	-2	-3	V
$I_{D(ON)}$	On state drain current	$V_{GS} = -10\text{V}$, $V_{DS} = -5\text{V}$	-30			A
$R_{DS(ON)}$	Static Drain-Source On-Resistance	$V_{GS} = -10\text{V}$, $I_D = -12\text{A}$ $T_J = 125^\circ\text{C}$		36	45	m Ω
		$V_{GS} = -4.5\text{V}$, $I_D = -8\text{A}$		52	65	
				51	66	
g_{FS}	Forward Transconductance	$V_{DS} = -5\text{V}$, $I_D = -12\text{A}$		22		S
V_{SD}	Diode Forward Voltage	$I_S = -1\text{A}$, $V_{GS} = 0\text{V}$		-0.76	-1	V
I_S	Maximum Body-Diode Continuous Current ^H				-12	A
DYNAMIC PARAMETERS						
C_{iss}	Input Capacitance			900	1125	pF
C_{oss}	Output Capacitance	$V_{GS} = 0\text{V}$, $V_{DS} = -20\text{V}$, $f = 1\text{MHz}$		97		pF
C_{rss}	Reverse Transfer Capacitance			68		pF
R_g	Gate resistance	$V_{GS} = 0\text{V}$, $V_{DS} = 0\text{V}$, $f = 1\text{MHz}$		14		Ω
SWITCHING PARAMETERS						
$Q_g(-10\text{V})$	Total Gate Charge			16.2	21	nC
$Q_g(-4.5\text{V})$	Total Gate Charge	$V_{GS} = -10\text{V}$, $V_{DS} = -20\text{V}$, $I_D = -12\text{A}$		7.2	9.4	nC
Q_{gs}	Gate Source Charge			3.8		nC
Q_{gd}	Gate Drain Charge			3.5		nC
$t_{D(on)}$	Turn-On DelayTime			6.2		ns
t_r	Turn-On Rise Time	$V_{GS} = -10\text{V}$, $V_{DS} = -20\text{V}$, $R_L = 1.4\Omega$, $R_{GEN} = 3\Omega$		8.4		ns
$t_{D(off)}$	Turn-Off DelayTime			44.8		ns
t_f	Turn-Off Fall Time			41.2		ns
t_{rr}	Body Diode Reverse Recovery Time	$I_F = -12\text{A}$, $dI/dt = 100\text{A}/\mu\text{s}$		21	27	ns
Q_{rr}	Body Diode Reverse Recovery Charge	$I_F = -12\text{A}$, $dI/dt = 100\text{A}/\mu\text{s}$		14		nC

A: The value of $R_{\theta JA}$ is measured with the device in a still air environment with $T_A = 25^\circ\text{C}$. The power dissipation P_{DSM} and current rating I_{DSM} are based on $T_{J(MAX)} = 150^\circ\text{C}$, using $t \leq 10\text{s}$ junction-to-ambient thermal resistance.

B: The power dissipation P_D is based on $T_{J(MAX)} = 175^\circ\text{C}$, using junction-to-case thermal resistance, and is more useful in setting the upper dissipation limit for cases where additional heatsinking is used.

C: Repetitive rating, pulse width limited by junction temperature $T_{J(MAX)} = 175^\circ\text{C}$.

D: The $R_{\theta JA}$ is the sum of the thermal impedance from junction to case $R_{\theta JC}$ and case to ambient.

E: The static characteristics in Figures 1 to 6 are obtained using $<300\mu\text{s}$ pulses, duty cycle 0.5% max.

F: These curves are based on the junction-to-case thermal impedance which is measured with the device mounted to a large heatsink, assuming a maximum junction temperature of $T_{J(MAX)} = 175^\circ\text{C}$. The SOA curve provides a single pulse rating.

G: These tests are performed with the device mounted on 1 in² FR-4 board with 2oz. Copper, in a still air environment with $T_A = 25^\circ\text{C}$.

H: The maximum current rating is limited by bond-wires.

THIS PRODUCT HAS BEEN DESIGNED AND QUALIFIED FOR THE CONSUMER MARKET. APPLICATIONS OR USES AS CRITICAL COMPONENTS IN LIFE SUPPORT DEVICES OR SYSTEMS ARE NOT AUTHORIZED. AOS DOES NOT ASSUME ANY LIABILITY ARISING OUT OF SUCH APPLICATIONS OR USES OF ITS PRODUCTS. AOS RESERVES THE RIGHT TO IMPROVE PRODUCT DESIGN, FUNCTIONS AND RELIABILITY WITHOUT NOTICE.

TYPICAL ELECTRICAL AND THERMAL CHARACTERISTICS: N-CANNEL

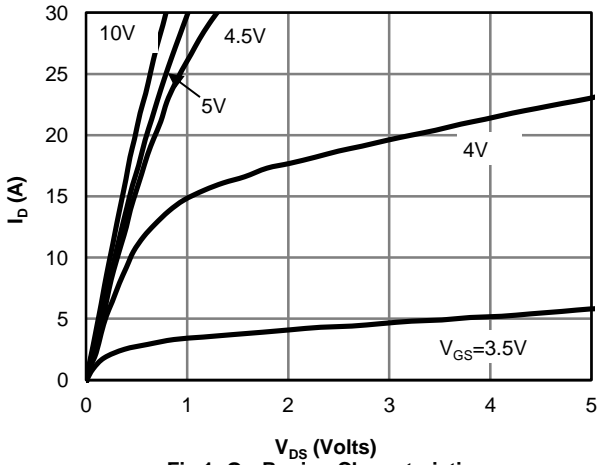

Fig 1: On-Region Characteristics

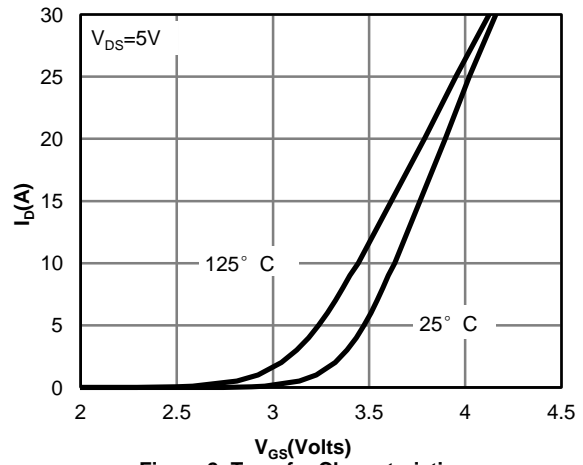

Figure 2: Transfer Characteristics

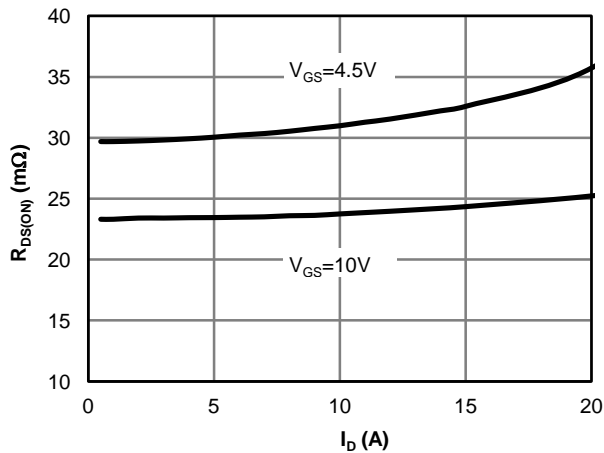

Figure 3: On-Resistance vs. Drain Current and Gate Voltage

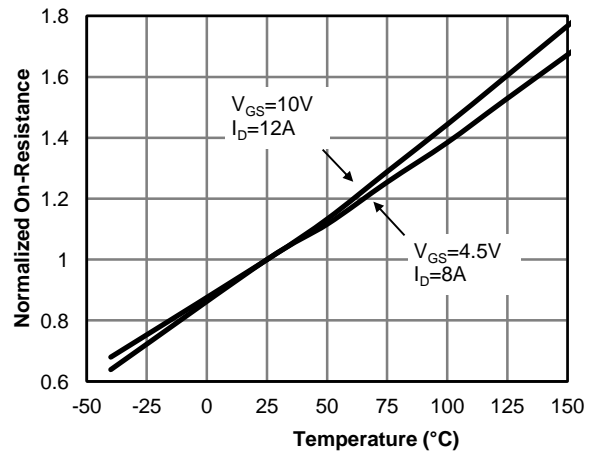

Figure 4: On-Resistance vs. Junction Temperature

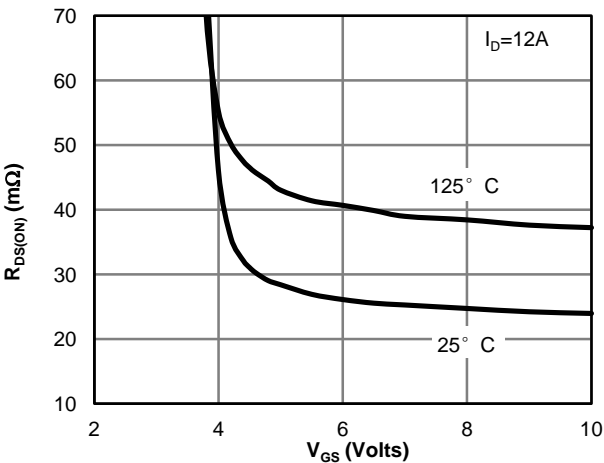

Figure 5: On-Resistance vs. Gate-Source Voltage

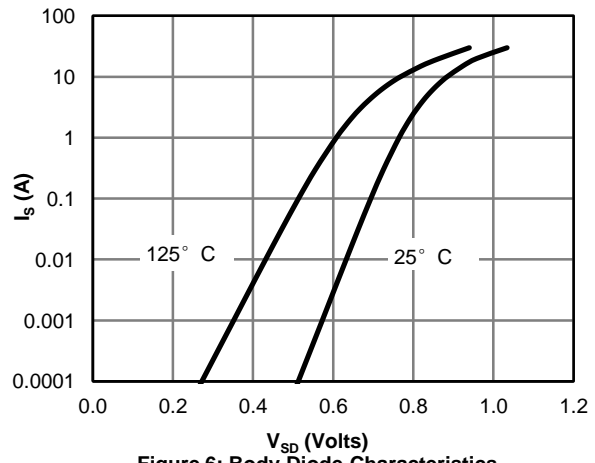

Figure 6: Body-Diode Characteristics

TYPICAL ELECTRICAL AND THERMAL CHARACTERISTICS: N-CHANNEL

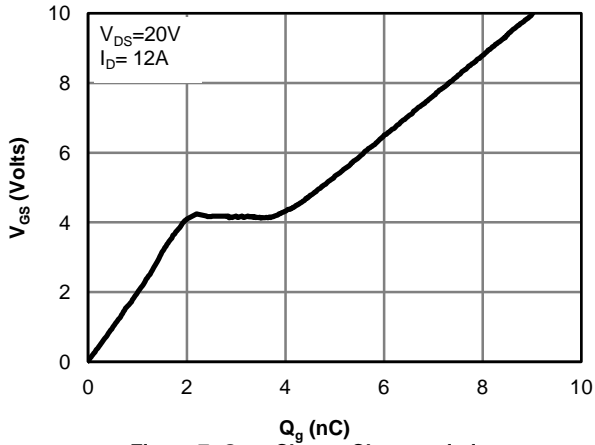

Figure 7: Gate-Charge Characteristics

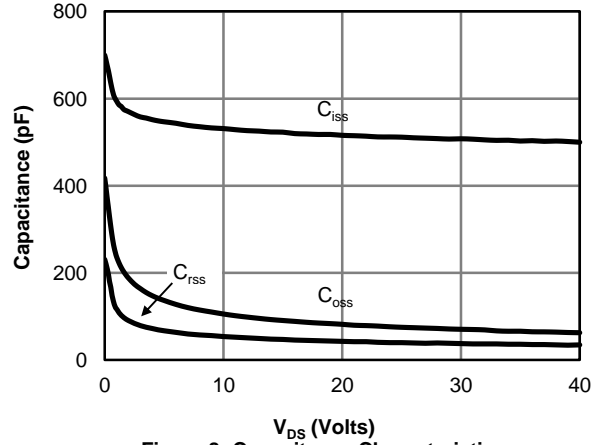

Figure 8: Capacitance Characteristics

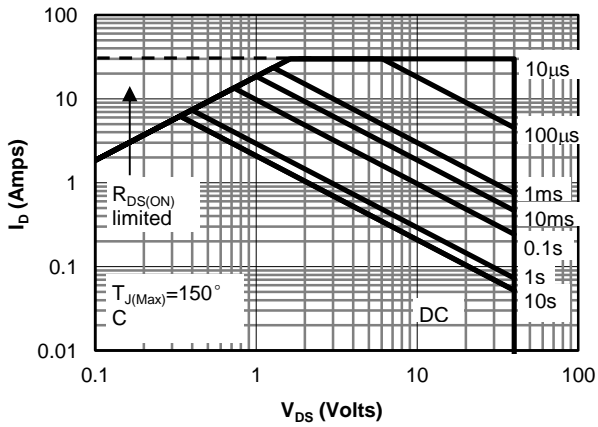

Figure 9: Maximum Forward Biased Safe Operating Area (Note E)

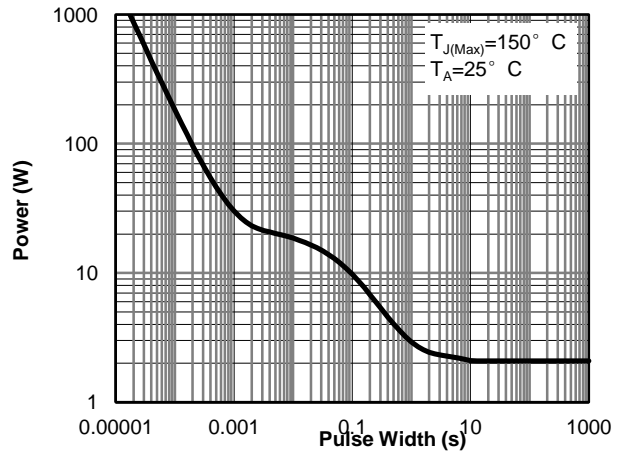

Figure 10: Single Pulse Power Rating Junction-to-Ambient (Note E)

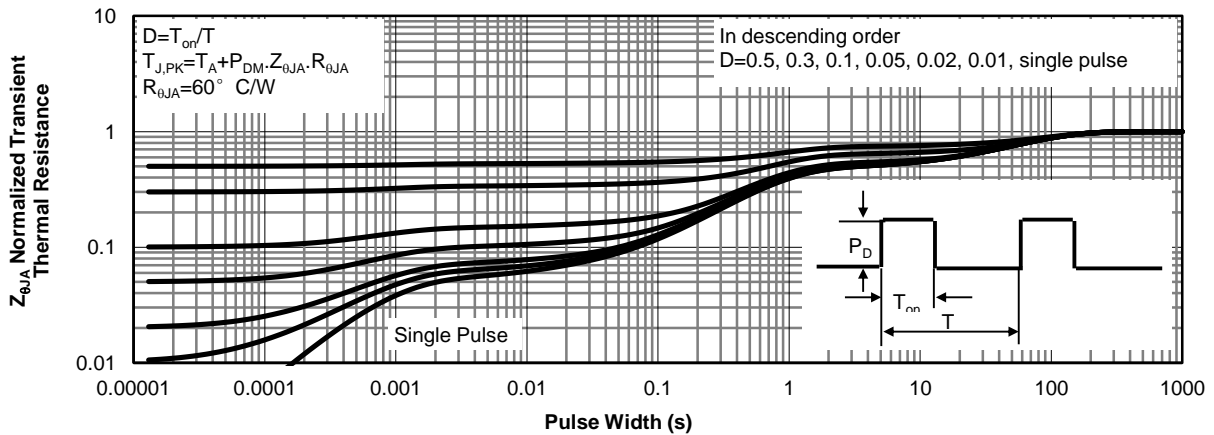
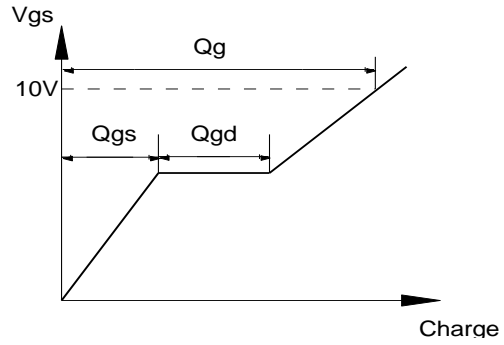
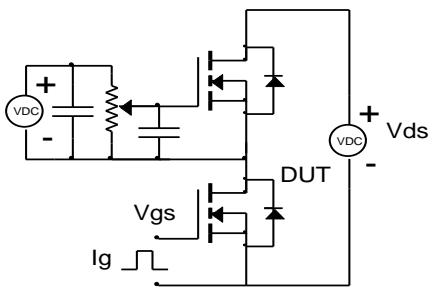
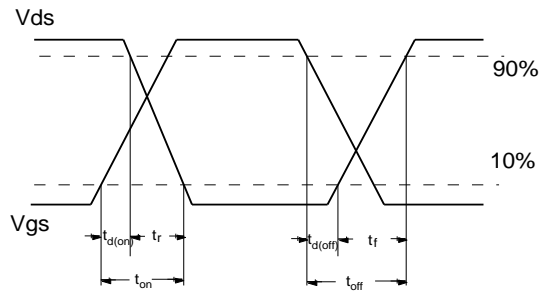
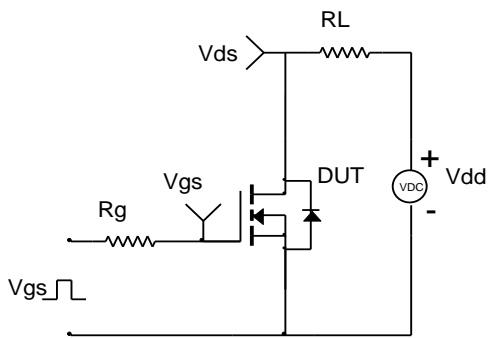

Figure 11: Normalized Maximum Transient Thermal Impedance

Gate Charge Test Circuit & Waveform



Resistive Switching Test Circuit & Waveforms



Unclamped Inductive Switching (UIS) Test Circuit & Waveforms

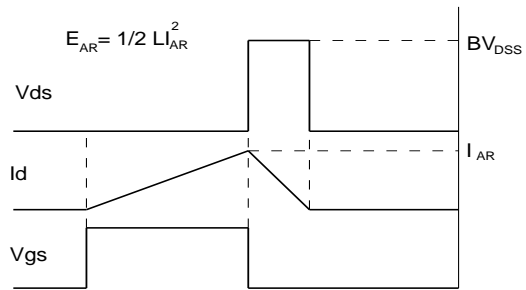
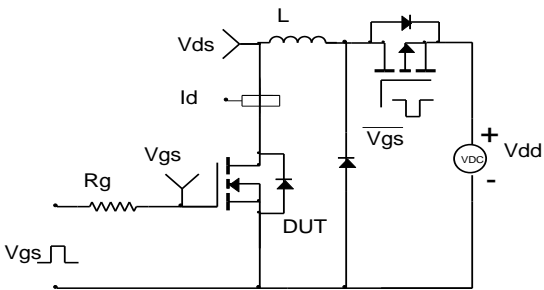

Diode Recovery Test Circuit & Waveforms

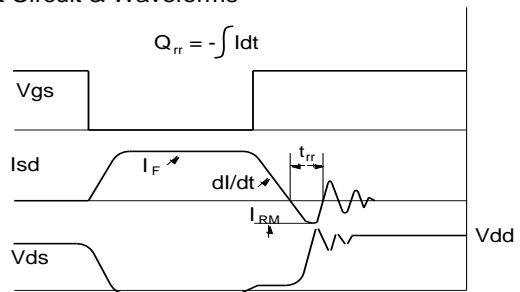
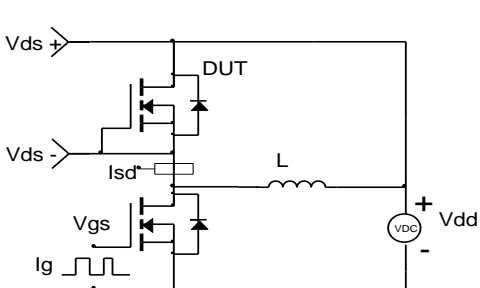

TYPICAL ELECTRICAL AND THERMAL CHARACTERISTICS: P-CHANNEL

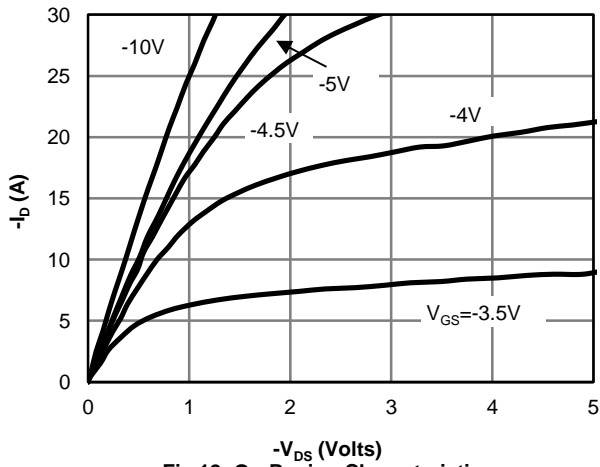

Fig 12: On-Region Characteristics

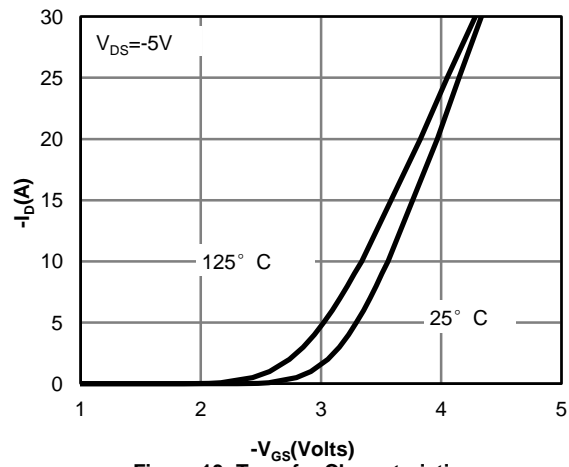

Figure 13: Transfer Characteristics

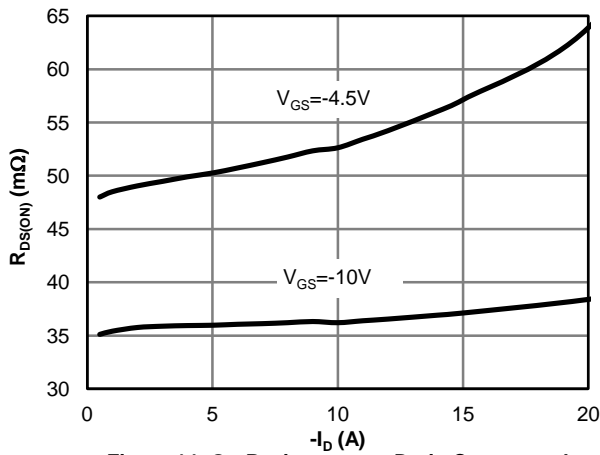

Figure 14: On-Resistance vs. Drain Current and Gate Voltage

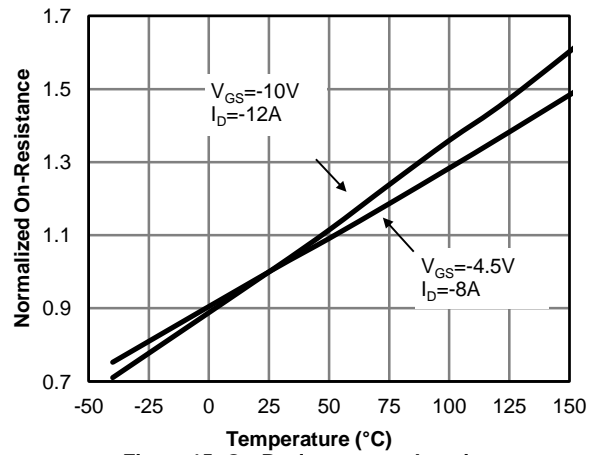

Figure 15: On-Resistance vs. Junction Temperature

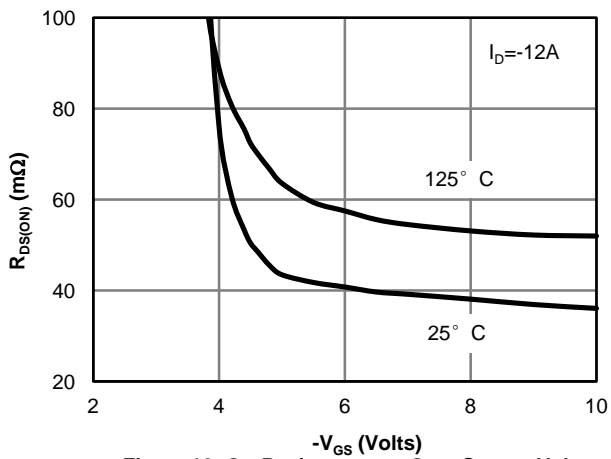

Figure 16: On-Resistance vs. Gate-Source Voltage

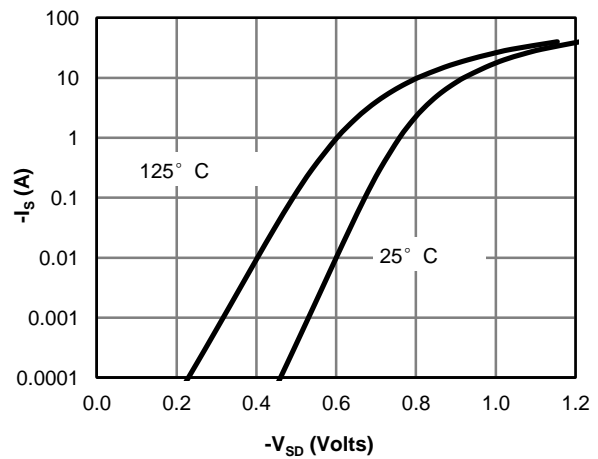

Figure 17: Body-Diode Characteristics

TYPICAL ELECTRICAL AND THERMAL CHARACTERISTICS: P-CHANNEL

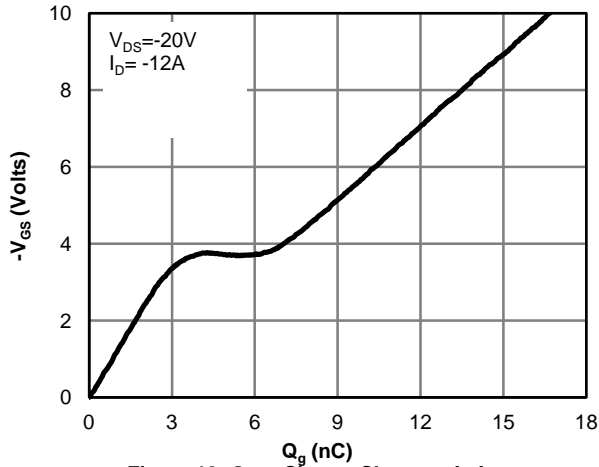

Figure 18: Gate-Charge Characteristics

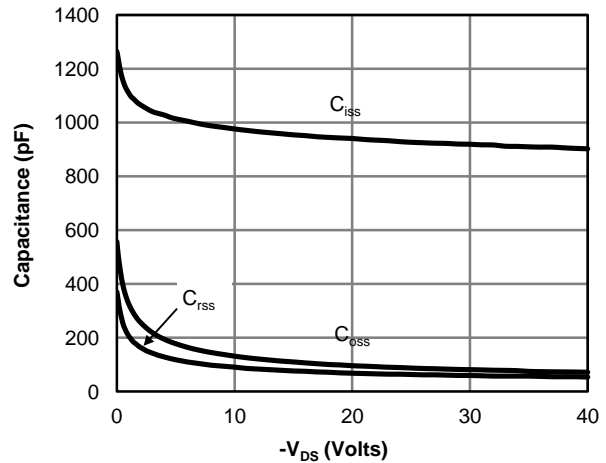

Figure 19: Capacitance Characteristics

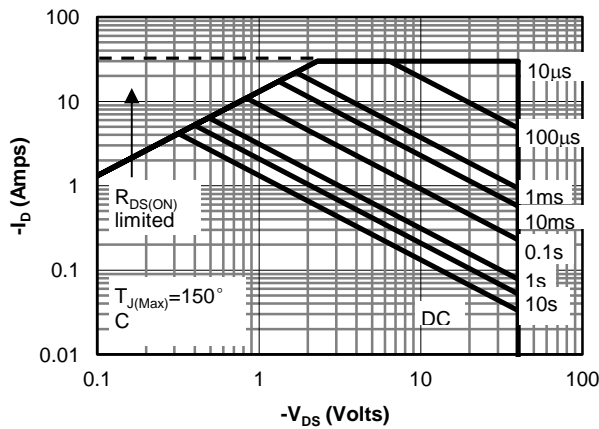

Figure 20: Maximum Forward Biased Safe Operating Area (Note E)

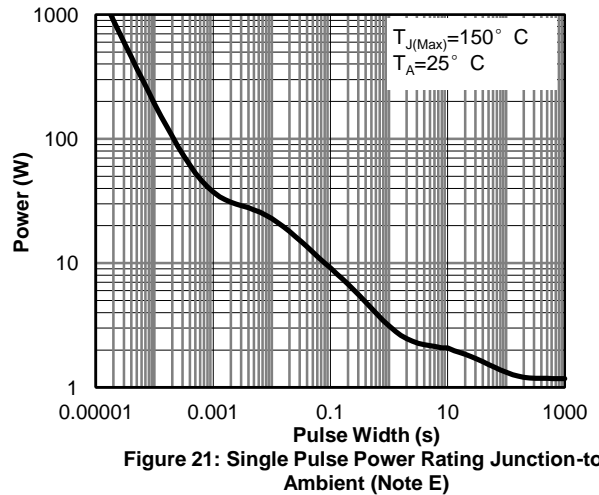

Figure 21: Single Pulse Power Rating Junction-to-Ambient (Note E)

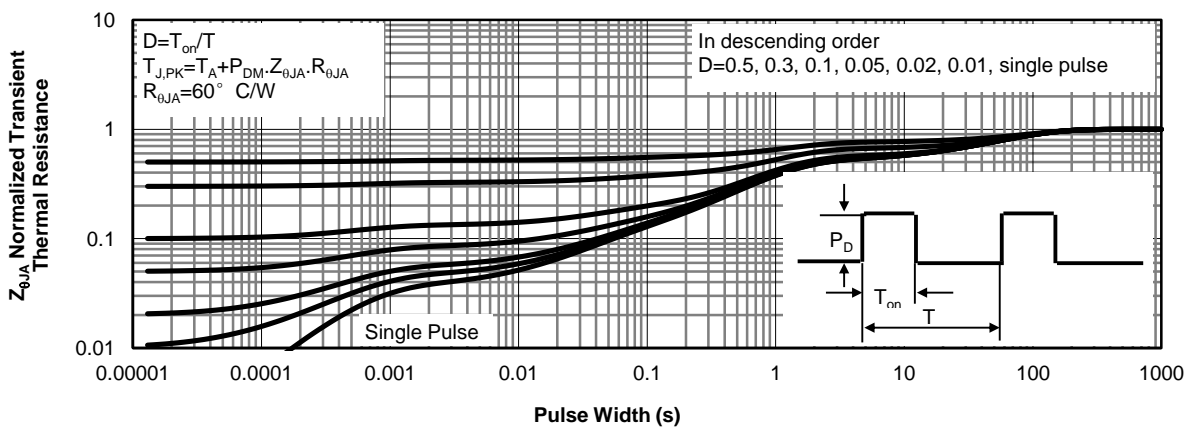
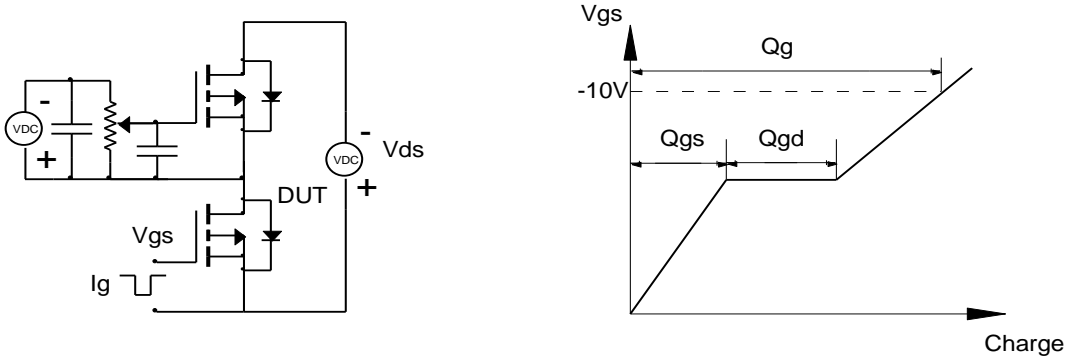
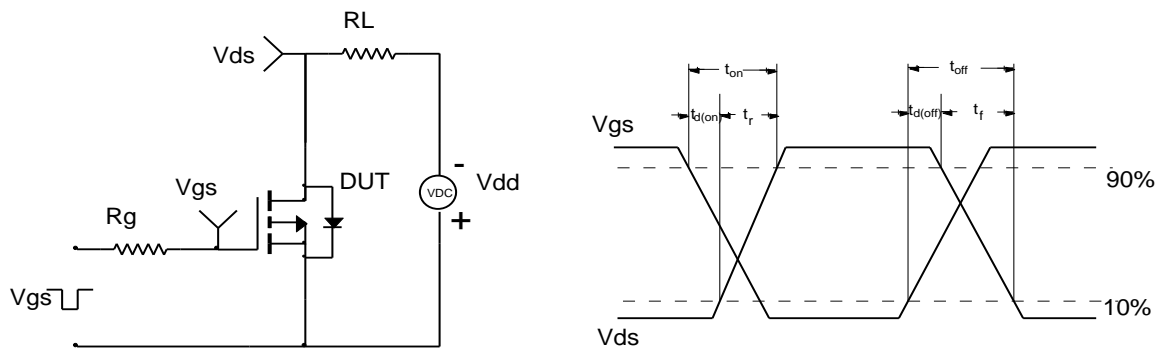

Figure 22: Normalized Maximum Transient Thermal Impedance

Gate Charge Test Circuit & Waveform



Resistive Switching Test Circuit & Waveforms



Unclamped Inductive Switching (UIS) Test Circuit & Waveforms

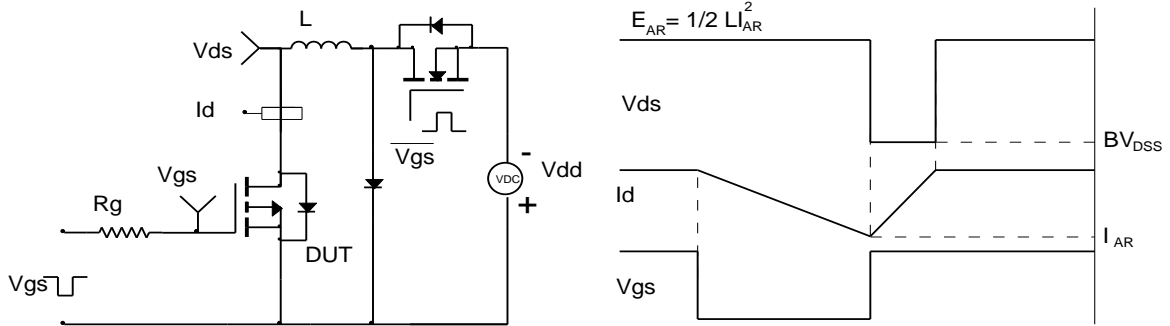

Diode Recovery Test Circuit & Waveforms

