

Description

The DML1008LDS is a single-channel load switch with very low on-resistance in a small package. It contains an N-channel MOSFET for up to V_{BIAS} , 1.5V input voltage operation, and 6A current channel with 3.2V to 5.5V bias supply. The load switch is controlled by a low-voltage control signal through the ON pin.

Applications

- Portable electronics and systems
- Notebooks and tablet computers
- Telecoms, networking, medicals and industrial equipment
- Set-top boxes, servers, and gateways
- SSDs

Features and Benefits

- Low $R_{DS(ON)}$ – Ensures On State Losses Are Minimized
- 0.8V to V_{BIAS} -1.5V Input Voltage Range
- 6A Continuous Current
- Low $R_{DS(ON)}$ Internal NFETs
8m Ω at $V_{BIAS} = 5V$, $V_{IN} = 1.05V$, $T_A = +85^\circ C$
- 35 μA Low Quiescent Current
- 10 μs Turn On Rise Time
- 3.2V to 5.5V Bias Voltage
- Integrated Quick Output Discharge Resistor
- Moisture Sensitivity: Level 1 per J-STD-020
- **Totally Lead-Free & Fully RoHS Compliant (Notes 1 & 2)**
- **Halogen and Antimony Free. "Green" Device (Note 3)**
- **For automotive applications requiring specific change control (i.e. parts qualified to AEC-Q100/101/104/200, PPAP capable, and manufactured in IATF 16949 certified facilities), please [contact us](mailto:contact@diodes.com) or your local Diodes representative. <https://www.diodes.com/quality/product-definitions/>**

V-DFN3030-8 (Type R)



Top View

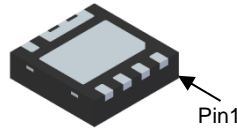

Bottom View

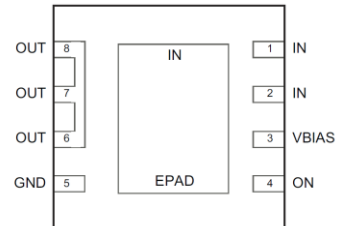
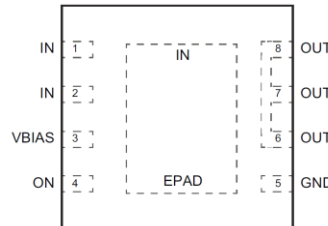

Ordering Information (Note 4)

Orderable Part Number	Package	Tape Width	Tape Pitch	Packing	
				Qty.	Carrier
DML1008LDS-7	V-DFN3030-8 (Type R)	8	4	3,000	Tape & Reel
DML1008LDS-13	V-DFN3030-8 (Type R)	12	8	3,000	Tape & Reel

- Notes:
1. No purposely added lead. Fully EU Directive 2002/95/EC (RoHS), 2011/65/EU (RoHS 2) & 2015/863/EU (RoHS 3) compliant.
 2. See <https://www.diodes.com/quality/lead-free/> for more information about Diodes Incorporated's definitions of Halogen- and Antimony-free, "Green" and Lead-free.
 3. Halogen- and Antimony-free "Green" products are defined as those which contain <900ppm bromine, <900ppm chlorine (<1500ppm total Br + Cl) and <1000ppm antimony compounds.
 4. For packaging details, go to our website at <https://www.diodes.com/design/support/packaging/diodes-packaging/>.

Marking Information

V-DFN3030-8 (Type R)

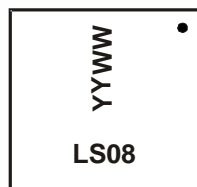

LS08 = Product Type Marking Code
 YYWW = Date Code Marking
 YY = Last Two Digits of Year (ex: 23 = 2023)
 WW = Week Code (01 to 53)

Typical Application Circuit

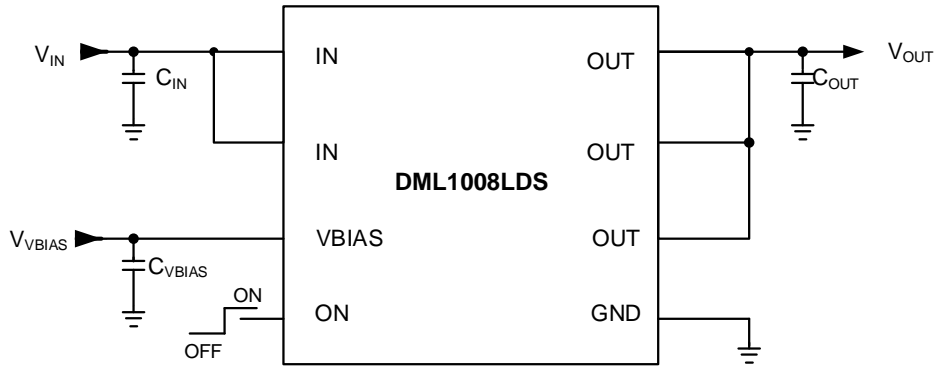

Pin Description

Pin Number	Pin Name	Pin Function
1, 2, EPAD	IN	Load Switch Input. Bypass capacitor is recommended to minimize input voltage dip.
3	VBIAS	Bias Voltage. Power supply input for the device.
4	ON	Enable Input. Load switch is on when ON is pulled high. Load switch is off when ON is pulled low. Do not leave floating.
5	GND	Ground.
6, 7, 8	OUT	Load Switch Output.

Functional Block Diagram

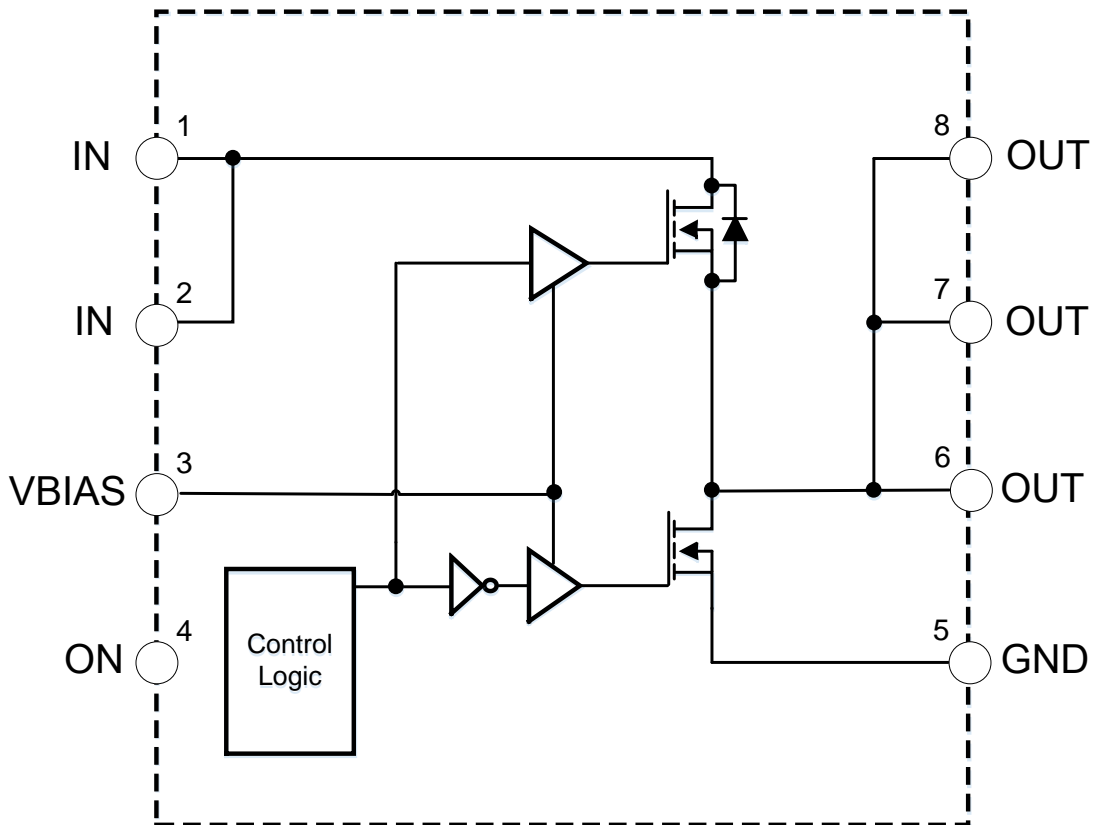

Absolute Maximum Rating

Parameter	Rating
IN, ON, VBIAS, OUT to GND Voltage	-0.3V to 6V
Junction Temperature (T _J)	+150°C
I _{MAX}	12A
Storage Temperature (T _S)	-65°C to +150°C
ESD Rating HBM/CDM	2kV/1kV

Recommended Operating Ranges

Parameter	Rating
Supply Voltage (V _{VBIAS})	3.2V to 5.5V
Input Voltage (V _{IN})	0.8V to V _{VBIAS} -1.5V
Ambient Temperature (T _A)	-40°C to +85°C
Package Thermal Resistance (θ _{JC})	+8°C/W
Package Thermal Resistance (θ _{JA})	+60°C/W

Electrical Characteristics (T_A = +25°C, V_{VBIAS} = 5V, V_{IN} = 1.05V, unless otherwise specified.)

Symbol	Parameter	Conditions	Min	Typ	Max	Unit
V _{IN}	IN Supply Voltage	V _{ON} = 5V	0.8	1.05	V _{VBIAS} -1.5	V
V _{VBIAS}	VBIAS Supply Voltage	—	3.2	5	5.5	V
I _D	Maximum Continuous Current	V _{ON} = 5V	—	6	—	A
I _{PLS}	Maximum Pulsed Switch Current	V _{IN} = V _{ON} = 5V Pulse < 300μs, 2% Duty Cycle	—	9	—	A
I _Q	Quiescent Supply Current of VBIAS	I _{OUT} = 0V, V _{ON} = 5V	—	35	—	μA
I _{OFF}	VBIAS Shutdown Supply Current	V _{ON} = 0V, V _{OUT} = 0V	—	—	2	μA
I _{INOFF}	IN Shutdown Supply Current	V _{ON} = 0V, V _{OUT} = 0V	—	—	2	μA
I _{ON}	ON Leakage Current	V _{ON} = 5V	—	—	1	μA
V _{ONH}	ON High Level Voltage	—	1.2	—	—	V
V _{ONL}	ON Low Level Voltage	—	—	—	0.5	V
Switching ON Resistance						
R _{ON}	Switch ON-State Resistance	I _{OUT} = -200mA, V _{ON} = 5V, V _{VBIAS} = 5V	—	—	8	mΩ
		I _{OUT} = -200mA, V _{ON} = 5V, V _{VBIAS} = 3.3V	—	—	10	mΩ
R _{PD}	Output Pull-Down Resistance	I _{OUT} = 15mA, V _{ON} = 0V	—	—	200	Ω

Switching Electrical Characteristics (T_A = +25°C, V_{VBIAS} = V_{ON} = 5V, V_{IN} = 1.05V, C_{IN} = 1μF, C_{OUT} = 0.1μF, unless otherwise specified.)

Symbol	Parameter	Min	Typ	Max	Unit
V_{IN} = 1.5V, V_{VBIAS} = V_{ON} = 5V					
t _{ON}	Turn-ON Time	10	—	65	μs
t _{D-ON}	Turn-ON Delay time	7.5	—	45	
t _R	Turn-ON Rise Time	5	—	33	
t _{OFF}	Turn-OFF Time	—	0.2	—	
t _F	Turn-OFF Fall Time	—	0.7	—	
V_{IN} = 1.05V, V_{VBIAS} = V_{ON} = 5V					
t _{ON}	Turn-ON Time	10	—	65	μs
t _{D-ON}	Turn-ON Delay time	7.5	—	45	
t _R	Turn-ON Rise Time	5	—	33	
t _{OFF}	Turn-OFF Time	—	0.2	—	
t _F	Turn-OFF Fall Time	—	0.7	—	

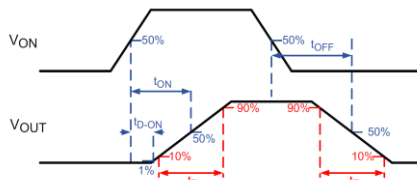

Performance Characteristics (@ $T_A = +25^\circ\text{C}$, unless otherwise specified.)

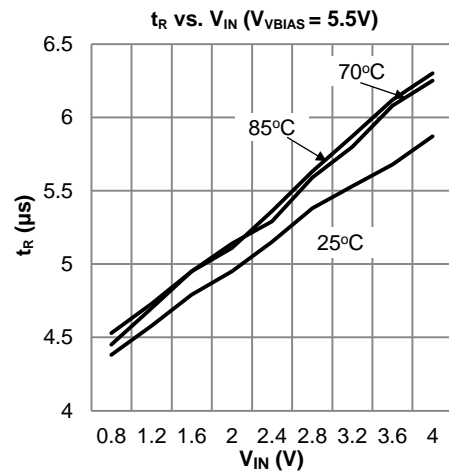
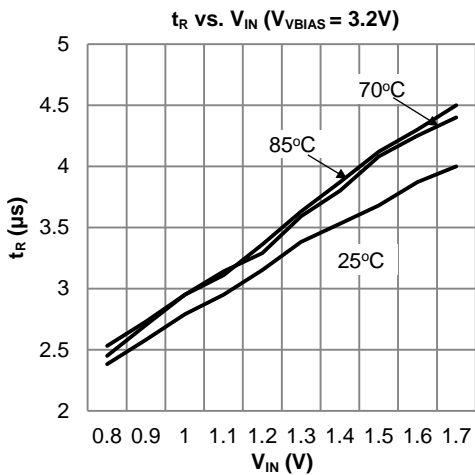
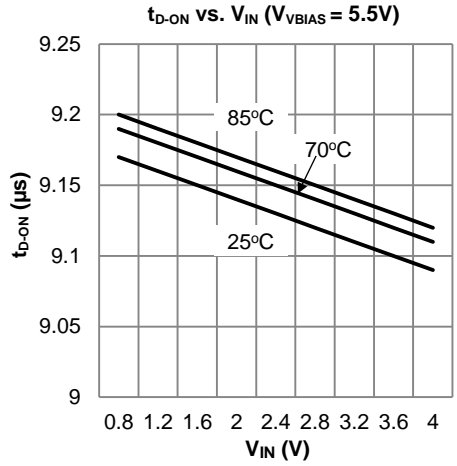
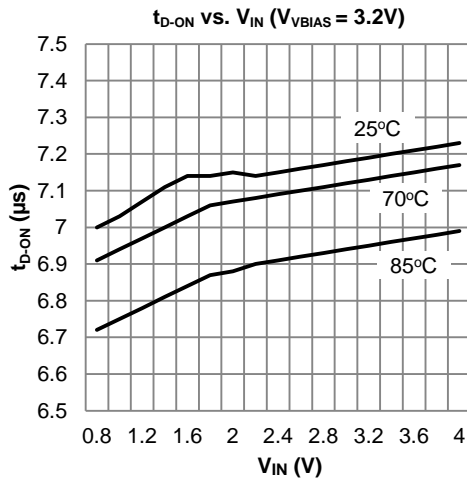
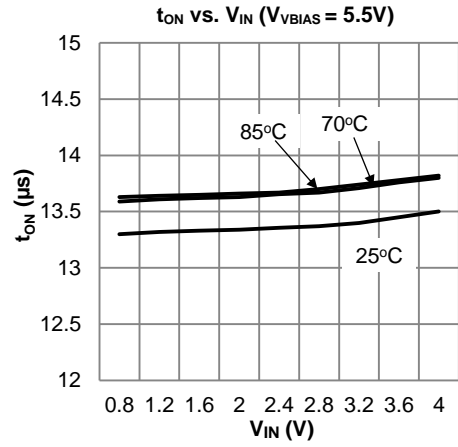
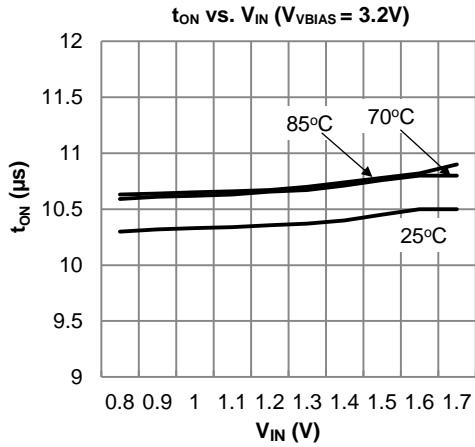

Performance Characteristics (@ $T_A = +25^\circ\text{C}$, unless otherwise specified. continued)

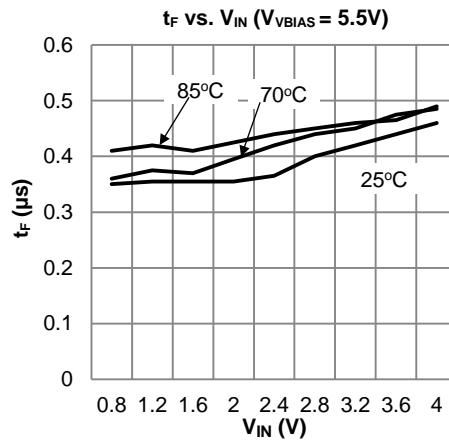
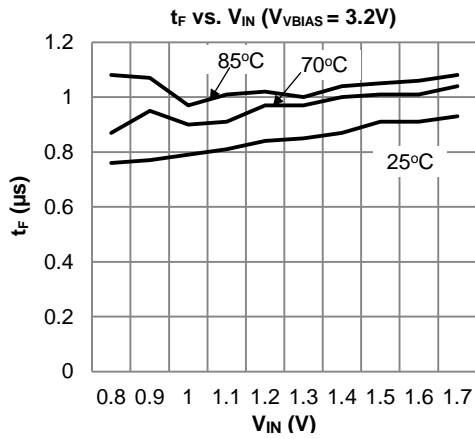
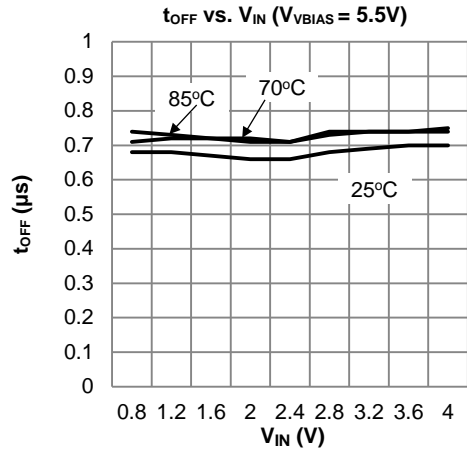
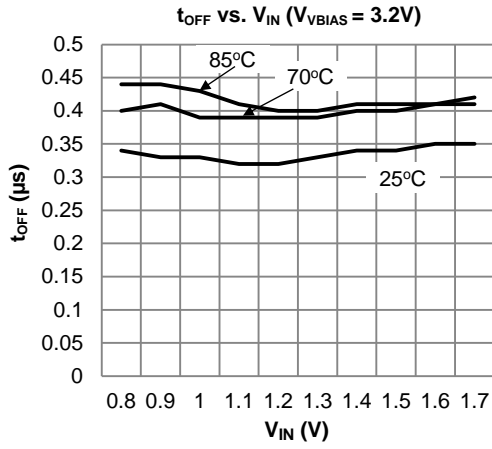

Performance Characteristics (@ $T_A = +25^\circ\text{C}$, unless otherwise specified. continued)

Turn-ON & Turn-ON Rise Times
 $V_{IN} = 1.05\text{V}$, $V_{VBIAS} = 5\text{V}$, $C_{IN} = 1\mu\text{F}$, $C_{OUT} = 0.1\mu\text{F}$,
 $R_{OUT} = 10\Omega$

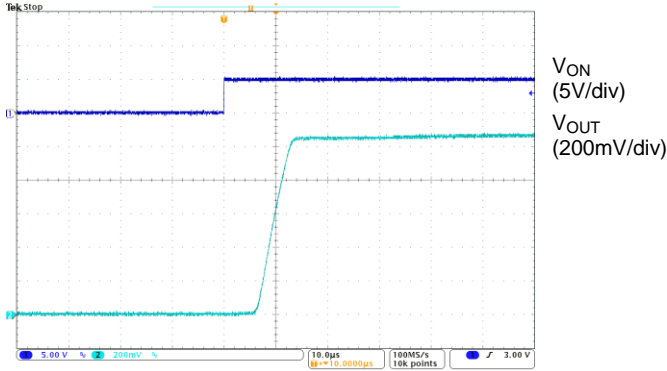

Turn-ON & Turn-ON Rise Times
 $V_{IN} = 1.05\text{V}$, $V_{VBIAS} = 3.2\text{V}$, $C_{IN} = 1\mu\text{F}$, $C_{OUT} = 0.1\mu\text{F}$,
 $R_{OUT} = 10\Omega$

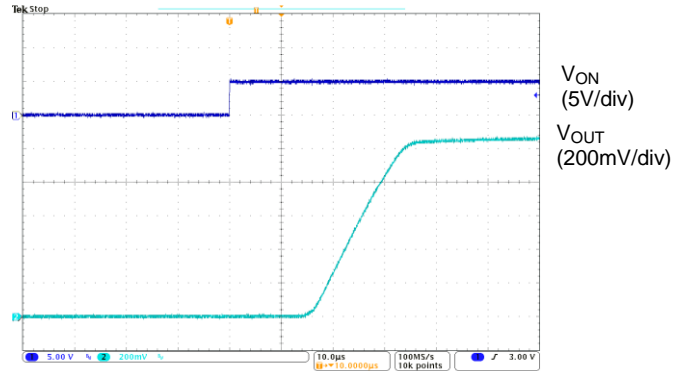

Turn-OFF & Turn-OFF Fall Times
 $V_{IN} = 1.05\text{V}$, $V_{VBIAS} = 5\text{V}$, $C_{IN} = 1\mu\text{F}$, $C_{OUT} = 0.1\mu\text{F}$,
 $R_{OUT} = 10\Omega$

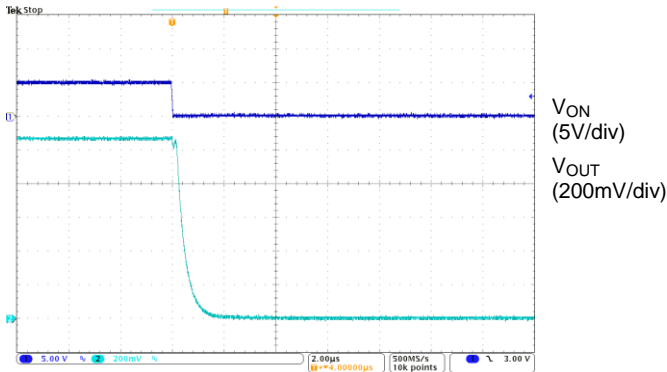

Turn-OFF & Turn-OFF Fall Times
 $V_{IN} = 1.05\text{V}$, $V_{VBIAS} = 3.2\text{V}$, $C_{IN} = 1\mu\text{F}$, $C_{OUT} = 0.1\mu\text{F}$,
 $R_{OUT} = 10\Omega$

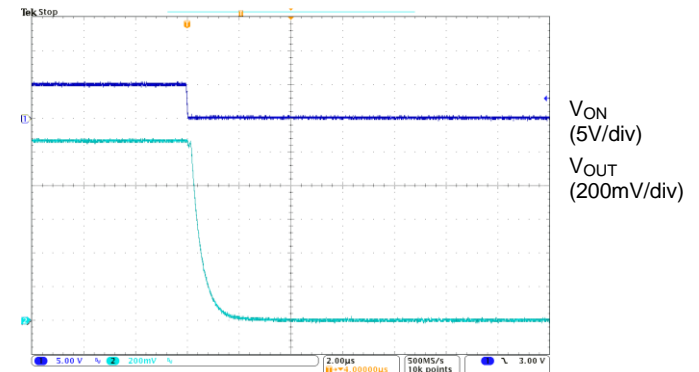

Turn-ON & Turn-OFF at $I_{OUT} = -10\text{A}$
 $V_{IN} = 1.05\text{V}$, $V_{VBIAS} = 5\text{V}$, $C_{IN} = 1\mu\text{F}$, $C_{OUT} = 0.1\mu\text{F}$,
 $R_{OUT} = 0.1\Omega$

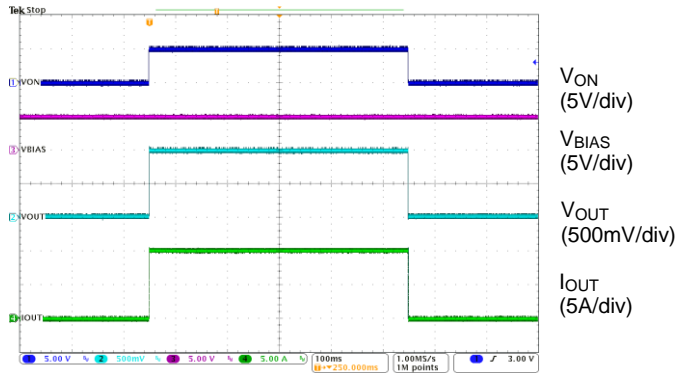

Turn-ON & Turn-OFF at $I_{OUT} = -10\text{A}$
 $V_{IN} = 1.05\text{V}$, $V_{VBIAS} = 3.2\text{V}$, $C_{IN} = 1\mu\text{F}$, $C_{OUT} = 0.1\mu\text{F}$,
 $R_{OUT} = 0.1\Omega$

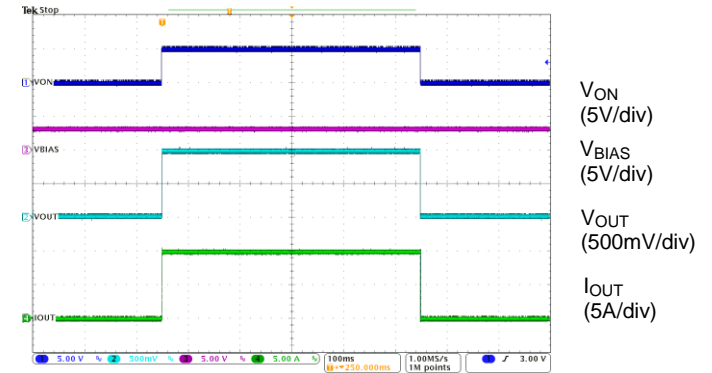

Application Information

General Description

The DML1008LDS is a single channel, 6A load switch in an 8-pin V-DFN3030-8 (Type R) package. To reduce the voltage drop in high current rails, the device implements an ultra-low resistance N-channel MOSFET which can be operated with input voltage range from 0.8V to 3.5V.

The device has very low leakage current during off state. This prevents downstream circuits from pulling high standby current from the supply. Integrated control logic, driver, power supply and discharge FET eliminate the needs for any external components, which reduce solution size and bill of materials (BOM) count.

Enable Control

The DML1008LDS device allows for enabling the MOSFET in an active-high configuration. When the VBIAS supply pin has an adequate voltage applied and the ON pin is at logic high level, the MOSFET will be enabled. Similarly, when the ON pin is at logic low level, the MOSFET will be disabled. An internal pull down resistor to ground on the ON pin ensures that the MOSFET will be disabled when not being driven.

Power sequencing

The DML1008LDS device will function with any power sequence, but the output turn-on delay performance may vary from what is specified. To archives the specified performance, there are two recommended power sequences:

- 1.) $V_{VBIAS} \rightarrow V_{IN} \rightarrow V_{ON}$
- 2.) $V_{IN} \rightarrow V_{VBIAS} \rightarrow V_{ON}$

Input Capacitor

A capacitor of 10 μ F or higher value is recommended to be placed close to the IN pins of DML1008LDS. This capacitor can reduce the voltage drop caused by the in-rush current during the turn-on transient of the load switch. A higher value capacitor can be used to further reduce the voltage drop during high-current application.

Output Capacitor

A capacitor of 0.1 μ F or higher value is recommended to be placed between the OUT pins and GND pin. The switching times are affected by the capacitance. A larger capacitor makes the initial turn-on transient smoother. This capacitor must be large enough to supply a fast transient load in order to prevent the output from dropping.

V_{IN} and V_{VBIAS} Voltage Range

For optimal on-resistance of load switch, make sure $V_{IN} \leq 1.5V + V_{VBIAS}$ and V_{VBIAS} is within the voltage range from 3.2V to 5.5V. On-resistance of load switch will be higher if $V_{IN} + 1.5V > V_{VBIAS}$. Resistance curves of a typical sample device at different $V_{VBIAS} = V_{IN}$ at $I_{OUT} = -200mA$ are shown as below.

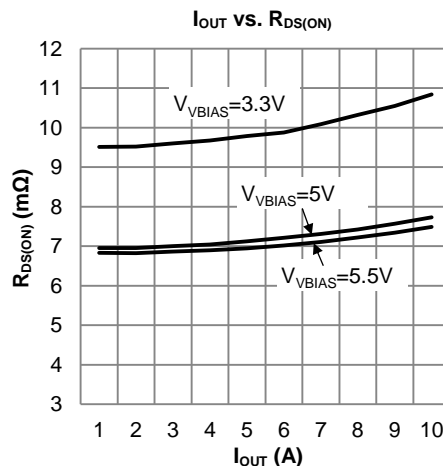
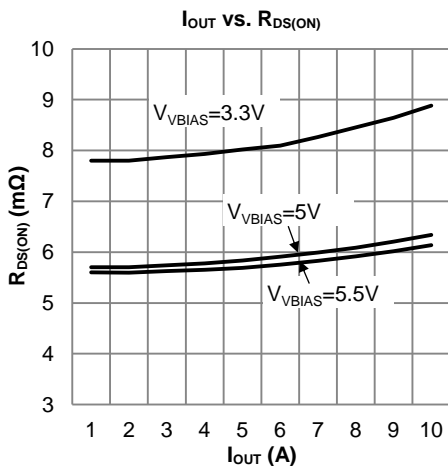

Application Information (continued)

Thermal Considerations

To ensure proper operation, the maximum junction temperature of the DML1008LDS should not exceed +150°C. Several factors attribute to the junction temperature rise: load current, MOSFET on-resistance, junction-to-ambient thermal resistance and ambient temperature. The maximum load current can be determined by:

$$I_{LOAD(MAX)} = \sqrt{\frac{T_{J(MAX)} - T_C}{\theta_{JC} \times R_{DS(ON)}}$$

Where

$I_{LOAD(MAX)}$ is the maximum allowable current on load (A). (6A for DML1008LDS)

$T_{J(MAX)}$ is the maximum allowable junction temperature.

T_C is the case temperature of the device.

θ_{JC} = junction to case thermal impedance. This parameter is highly dependent upon PCB layout.

PCB Layout Consideration

1. Place the input/output capacitors C_{IN} and C_{OUT} as close as possible to the IN and OUT pins.
2. The power traces which are IN trace, OUT trace and GND trace. They should be short, wide and directly for minimize parasitic inductance.
3. Place C_{VBIAS} capacitor near the device pin.
4. Connect the signal ground to the GND pin, and keep a single connection from GND pin to the power ground behind the input or output capacitors.
5. For better power dissipation, holes are recommended to connect to the exposed pad's landing area with a large copper polygon on the other side of the printed circuit board. The copper polygons and exposed pad shall connect to IN pin on the printed circuit board.

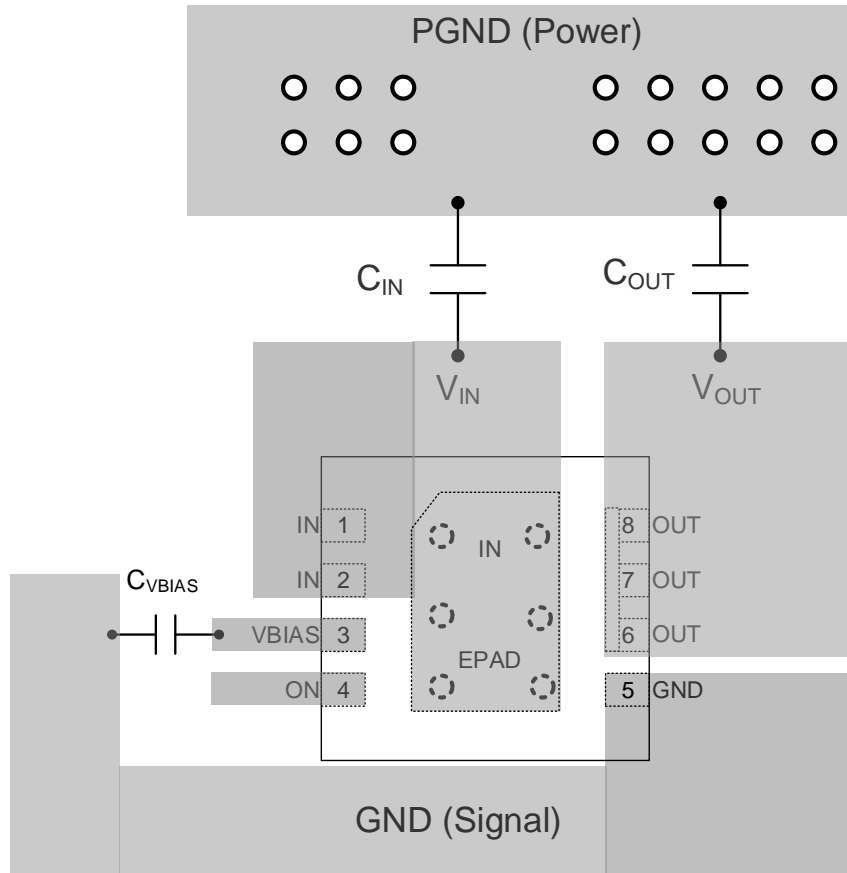

Package Outline Dimensions

Please see <http://www.diodes.com/package-outlines.html> for the latest version.

V-DFN3030-8 (Type R)

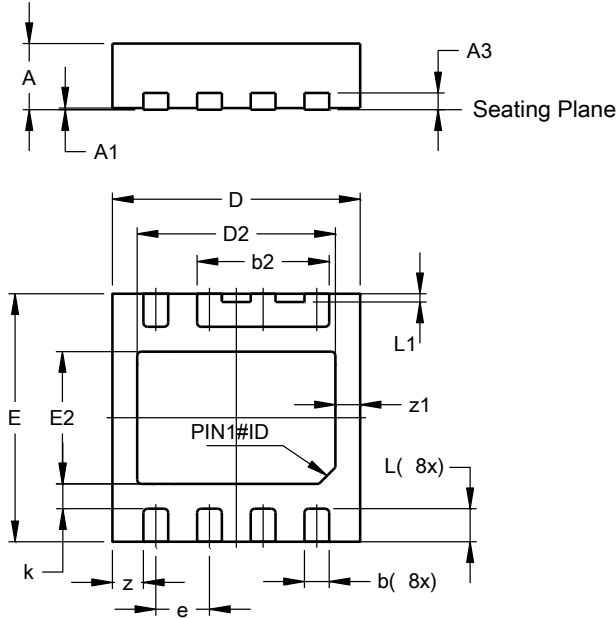

V-DFN3030-8 (Type R)			
Dim	Min	Max	Typ
A	0.77	0.83	0.80
A1	0.00	0.05	0.03
A3	--	--	0.203
b	0.25	0.35	0.30
b2	1.55	1.65	1.60
D	2.95	3.05	3.00
D2	2.30	2.50	2.40
E	2.95	3.05	3.00
E2	1.50	1.70	1.60
e	0.65 BSC		
k	--	--	0.30
L	0.35	0.45	0.40
L1	0.05	0.15	0.10
z	--	--	0.375
z1	--	--	0.30
All Dimensions in mm			

Suggested Pad Layout

Please see <http://www.diodes.com/package-outlines.html> for the latest version.

V-DFN3030-8 (Type R)

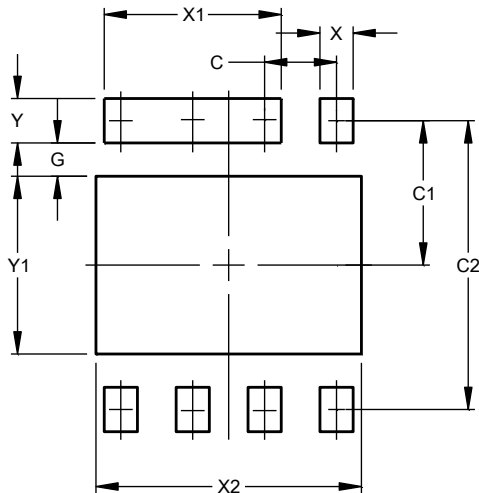

Dimensions	Value (in mm)
C	0.65
C1	1.30
C2	2.60
G	0.30
X	0.30
X1	1.60
X2	2.40
Y	0.40
Y1	1.60

Surface Mount Reel Specifications

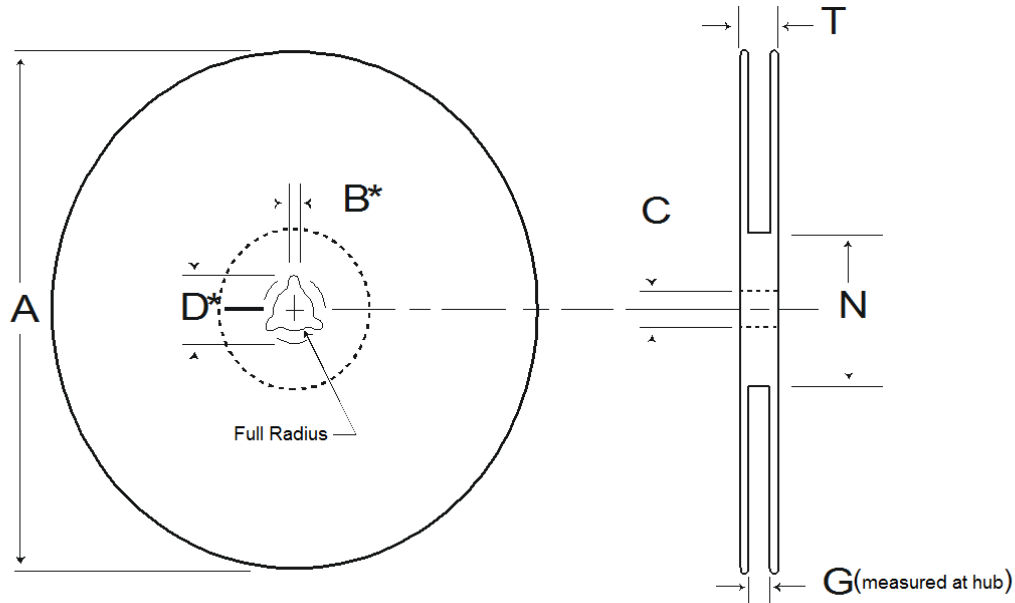

* Drive spokes optional. If used, dimensions with asterisks apply

Tape Width	Reel Size	A (mm)	B Max (mm)	C (mm)	D Max (mm)	N Min (mm)	G (mm)	T Max (mm)
8mm	7"	178 ±2	2.0 +0.5 -0	13 +0.5 -0.2	20.5 ±0.2	55 ±5	8.4 +1.5 -0.0	14.4
12mm	13"	330 ±2	2.0 +0.5 -0	13 +0.5 -0.2	20.5 ±0.2	100 ±5	12.4 +2.0 -0.0	18.4

Tape Leader and Trailer Specifications (Notes 5 and 6)

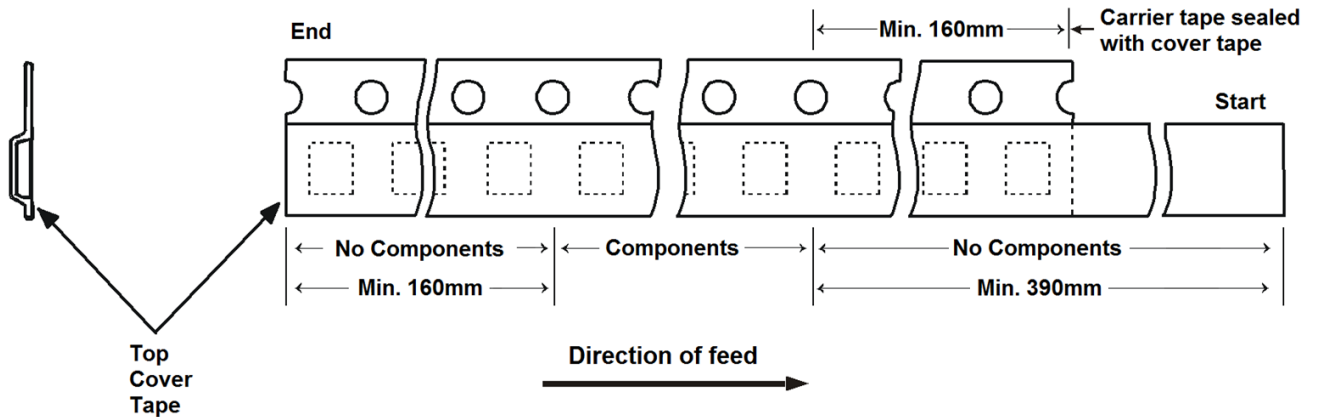

- Notes:
- There shall be a leader of at least 230mm which may consist of carrier tape and/or cover tape or a start tape followed by at least 160mm of empty carrier tape sealed with cover tape.
 - There shall be a trailer of at least 160mm of empty carrier tape sealed with cover tape. The entire carrier tape must release from the reel hub as the last portion of the tape unwinds from the reel without damage to the carrier tape and the remaining components in the cavities.

IMPORTANT NOTICE

1. DIODES INCORPORATED (Diodes) AND ITS SUBSIDIARIES MAKE NO WARRANTY OF ANY KIND, EXPRESS OR IMPLIED, WITH REGARDS TO ANY INFORMATION CONTAINED IN THIS DOCUMENT, INCLUDING, BUT NOT LIMITED TO, THE IMPLIED WARRANTIES OF MERCHANTABILITY, FITNESS FOR A PARTICULAR PURPOSE OR NON-INFRINGEMENT OF THIRD PARTY INTELLECTUAL PROPERTY RIGHTS (AND THEIR EQUIVALENTS UNDER THE LAWS OF ANY JURISDICTION).
2. The Information contained herein is for informational purpose only and is provided only to illustrate the operation of Diodes' products described herein and application examples. Diodes does not assume any liability arising out of the application or use of this document or any product described herein. This document is intended for skilled and technically trained engineering customers and users who design with Diodes' products. Diodes' products may be used to facilitate safety-related applications; however, in all instances customers and users are responsible for (a) selecting the appropriate Diodes products for their applications, (b) evaluating the suitability of Diodes' products for their intended applications, (c) ensuring their applications, which incorporate Diodes' products, comply the applicable legal and regulatory requirements as well as safety and functional-safety related standards, and (d) ensuring they design with appropriate safeguards (including testing, validation, quality control techniques, redundancy, malfunction prevention, and appropriate treatment for aging degradation) to minimize the risks associated with their applications.
3. Diodes assumes no liability for any application-related information, support, assistance or feedback that may be provided by Diodes from time to time. Any customer or user of this document or products described herein will assume all risks and liabilities associated with such use, and will hold Diodes and all companies whose products are represented herein or on Diodes' websites, harmless against all damages and liabilities.
4. Products described herein may be covered by one or more United States, international or foreign patents and pending patent applications. Product names and markings noted herein may also be covered by one or more United States, international or foreign trademarks and trademark applications. Diodes does not convey any license under any of its intellectual property rights or the rights of any third parties (including third parties whose products and services may be described in this document or on Diodes' website) under this document.
5. Diodes' products are provided subject to Diodes' Standard Terms and Conditions of Sale (<https://www.diodes.com/about/company/terms-and-conditions/terms-and-conditions-of-sales/>) or other applicable terms. This document does not alter or expand the applicable warranties provided by Diodes. Diodes does not warrant or accept any liability whatsoever in respect of any products purchased through unauthorized sales channel.
6. Diodes' products and technology may not be used for or incorporated into any products or systems whose manufacture, use or sale is prohibited under any applicable laws and regulations. Should customers or users use Diodes' products in contravention of any applicable laws or regulations, or for any unintended or unauthorized application, customers and users will (a) be solely responsible for any damages, losses or penalties arising in connection therewith or as a result thereof, and (b) indemnify and hold Diodes and its representatives and agents harmless against any and all claims, damages, expenses, and attorney fees arising out of, directly or indirectly, any claim relating to any noncompliance with the applicable laws and regulations, as well as any unintended or unauthorized application.
7. While efforts have been made to ensure the information contained in this document is accurate, complete and current, it may contain technical inaccuracies, omissions and typographical errors. Diodes does not warrant that information contained in this document is error-free and Diodes is under no obligation to update or otherwise correct this information. Notwithstanding the foregoing, Diodes reserves the right to make modifications, enhancements, improvements, corrections or other changes without further notice to this document and any product described herein. This document is written in English but may be translated into multiple languages for reference. Only the English version of this document is the final and determinative format released by Diodes.
8. Any unauthorized copying, modification, distribution, transmission, display or other use of this document (or any portion hereof) is prohibited. Diodes assumes no responsibility for any losses incurred by the customers or users or any third parties arising from any such unauthorized use.
9. This Notice may be periodically updated with the most recent version available at <https://www.diodes.com/about/company/terms-and-conditions/important-notice>

DIODES is a trademark of Diodes Incorporated in the United States and other countries.
The Diodes logo is a registered trademark of Diodes Incorporated in the United States and other countries.
© 2023 Diodes Incorporated. All Rights Reserved.

www.diodes.com