

features

- Dual-Input, Single-Output MOSFET Switch With No Reverse Current Flow (No Parasitic Diodes)
- IN1 . . . 250-mΩ, 500-mA N-Channel; 16-μA Max Supply Current
- IN2 . . . 1.3-Ω, 10-mA P-Channel; 1.5-μA Max Supply Current (V_{AUX} Mode)
- Advanced Switch Control Logic
- CMOS- and TTL-Compatible Enable Input
- Controlled Rise, Fall, and Transition Times
- 2.7-V to 4 V Operating Range
- SOT-23-5 and SOIC-8 Package
- -40°C to 70°C Ambient Temperature Range
- 2-kV Human-Body-Model, 750-V CDM, 200-V Machine-Model Electrostatic-Discharge Protection

typical applications

- Notebook and Desktop PCs
- Palmtops and PDAs

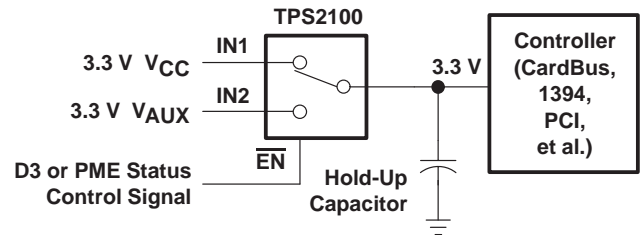

Figure 1. Typical Dual-Input Single-Output Application

description

The TPS2100 and TPS2101 are dual-input, single-output power switches designed to provide uninterrupted output voltage when transitioning between two independent power supplies. Both devices combine one n-channel (250 mΩ) and one p-channel (1.3 Ω) MOSFET with a single output. The p-channel MOSFET (IN2) is used with auxiliary power supplies that deliver lower current for standby modes. The n-channel MOSFET (IN1) is used with a main power supply that delivers higher current required for normal operation. Low on-resistance makes the n-channel the ideal path for higher main supply current when power-supply regulation and system voltage drops are critical. When using the p-channel MOSFET, quiescent current is reduced to 0.75 μA to decrease the demand on the standby power supply. The MOSFETs in the TPS2100 and TPS2101 do not have the parasitic diodes, found in discrete MOSFETs, which allow the devices to prevent back-flow current when the switch is off.

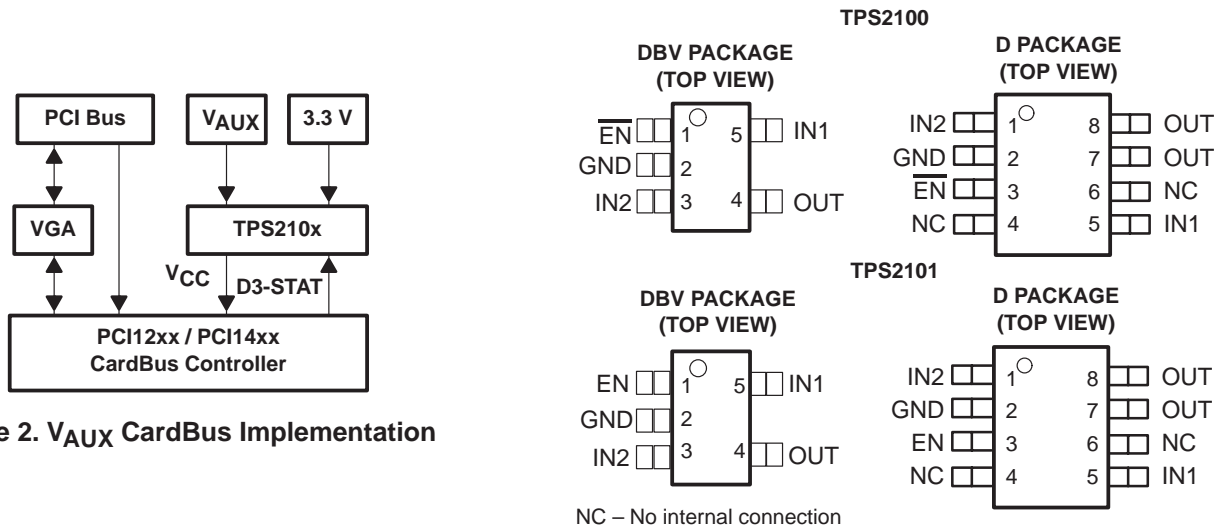

Figure 2. V_{AUX} CardBus Implementation



Please be aware that an important notice concerning availability, standard warranty, and use in critical applications of Texas Instruments semiconductor products and disclaimers thereto appears at the end of this data sheet.

TPS2100, TPS2101 V_{AUX} POWER-DISTRIBUTION SWITCHES

SLVS197D – JUNE 1999 – REVISED JUNE 2000

AVAILABLE OPTIONS

T _J	DEVICE	ENABLE	PACKAGED DEVICES	
			SOT-23-5 (DBV)†	SOIC-8 (D)
-40°C to 85°C	TPS2100	$\overline{\text{EN}}$	TSP2100DBV†	TPS2100D
	TPS2101	EN	TPS2101DBV†	TPS2101D

Both packages are available left-end taped and reeled. Add an R suffix to the D device type (e.g., TPS2101DR).

† Add T (e.g., TPS2100DBVT) to indicate tape and reel at order quantity of 250 parts.

Add R (e.g., TPS2100DBVR) to indicate tape and reel at order quantity of 3000 parts.

TPS2100 functional block diagram

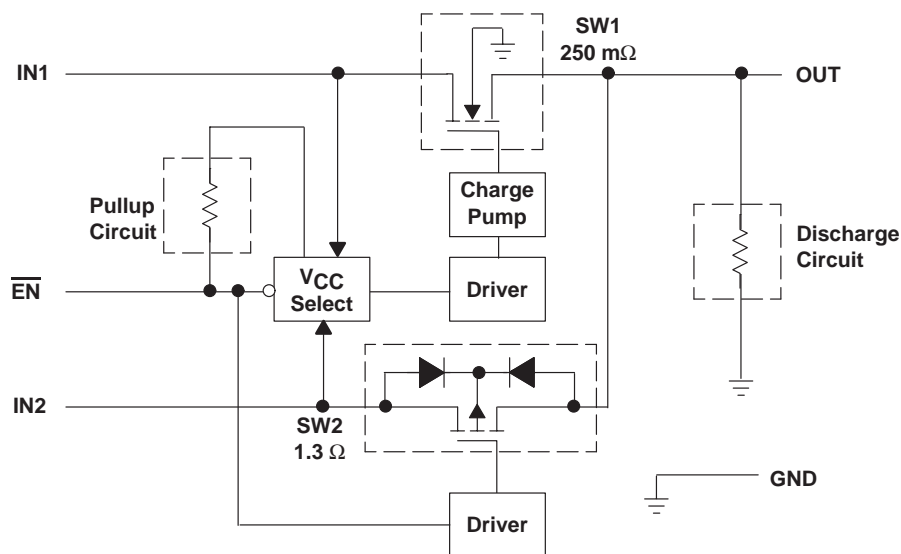

TPS2101 functional block diagram

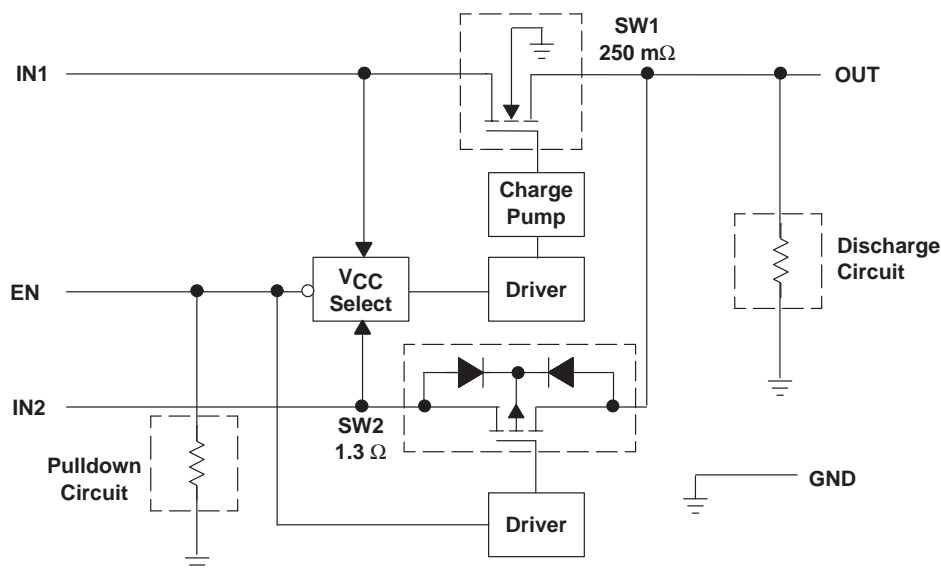

Function Tables

TPS2100			
VIN1	VIN2	EN	OUT
0 V	0 V	XX	GND
0 V	3.3 V	L	GND
3.3 V	3.3 V	L	VIN1
3.3 V	0 V	L	VIN1
0 V	3.3 V	H	VIN2
3.3 V	0 V	H	VIN2
3.3 V	3.3 V	H	VIN2

TPS2101			
VIN1	VIN2	EN	OUT
0 V	0 V	XX	GND
0 V	3.3 V	H	GND
3.3 V	3.3 V	H	VIN1
3.3 V	0 V	H	VIN1
0 V	3.3 V	L	VIN2
3.3 V	0 V	L	VIN2
3.3 V	3.3 V	L	VIN2

XX = don't care

Terminal Functions

TERMINAL						DESCRIPTION
NAME	NO.				I/O	
	TPS2100		TPS2101			
	DBV	D	DBV	D		
EN			1	3		Active-high enable for IN1-OUT switch
EN	1	3			I	Active-low enable for IN1-OUT switch
GND	2	2	2	2	I	Ground
IN1	5	5	5	5	I	Main Input voltage, NMOS drain (250 mΩ)
IN2	3	1	3	1	I	Auxilliary input voltage, PMOS drain (1.3 Ω)
OUT	4	7, 8	4	7, 8	O	Power switch output
NC		4, 6		4, 6		No connection

detailed description

power switches

n-channel MOSFET

The IN1-OUT n-channel MOSFET power switch has a typical on-resistance of 250 mΩ at 3.3-V input voltage, and is configured as a high-side switch.

p-channel MOSFET

The IN2-OUT p-channel MOSFET power switch with typical on-resistance of 1.3 Ω at 3.3-V input voltage and is configured as a high-side switch. When operating, the p-channel MOSFET quiescent current is reduced to less than 1.5 μA.

charge pump

An internal charge pump supplies power to the driver circuit and provides the necessary voltage to pull the gate of the MOSFET above the source. The charge pump operates from input voltages as low as 2.7 V and requires very little supply current.

driver

The driver controls the gate voltage of the IN1-OUT and IN2-OUT power switches. To limit large current surges and reduce the associated electromagnetic interference (EMI) produced, the drivers incorporate circuitry that controls the rise times and fall times of the output voltage.

TPS2100, TPS2101

V_{AUX} POWER-DISTRIBUTION SWITCHES

SLVS197D – JUNE 1999 – REVISED JUNE 2000

detailed description (continued)

enable

The logic enable will turn on the IN2-OUT power switch when a logic high is present on \overline{EN} (TPS2100) or logic low is present on EN (TPS2101). A logic low input on \overline{EN} (TPS2100) or logic high on EN (TPS2101) restores bias to the drive and control circuits and turns on the IN1-OUT power switch. The enable input is compatible with both TTL and CMOS logic levels.

the V_{AUX} application for CardBus controllers

The PC Card specification requires the support of V_{AUX} to the CardBus controller as well as to the PC Card sockets. Both are 3.3-V requirements; however the CardBus controller's current demand from the V_{AUX} supply is limited to 10 μ A, whereas the PC Card may consume as much as 200 mA. In either implementation, if support of a wake-up event is required, the controller and the socket will transition from the 3.3-V V_{CC} rail to the 3.3-V V_{AUX} rail when the equipment moves into a low power mode such as D3. The transition from V_{CC} to V_{AUX} needs to be seamless in order to maintain all memory and register information in the system. If V_{AUX} is not supported, the system will lose all register information when it transitions to the D3 state.

absolute maximum ratings over operating free-air temperature (unless otherwise noted)[†]

Input voltage range, V _{I(IN1)} (see Note1)	–0.3 V to 5 V
Input voltage range, V _{I(IN2)} (see Note1)	–0.3 V to 5 V
Input voltage range, V _I at \overline{EN} or EN	–0.3 V to 5 V
Output voltage range, V _O (see Note 1)	–0.3 V to 5 V
Continuous output current, I _{O(IN1)}	700 mA
Continuous output current, I _{O(IN2)}	70 mA
Continuous total power dissipation	See dissipation rating table
Operating virtual junction temperature range, T _J	–40°C to 85°C
Storage temperature range, T _{stg}	–65°C to 150°C
Lead temperature soldering 1,6 mm (1/16 inch) from case for 10 seconds	260°C
Electrostatic discharge (ESD) protection: Human body model	2 kV
Machine model	200 V
Charged device model (CDM)	750 V

[†] Stresses beyond those listed under “absolute maximum ratings” may cause permanent damage to the device. These are stress ratings only, and functional operation of the device at these or any other conditions beyond those indicated under “recommended operating conditions” is not implied. Exposure to absolute-maximum-rated conditions for extended periods may affect device reliability.

NOTE 1: All voltages are with respect to GND.

DISSIPATION RATING TABLE

PACKAGE	T _A < 25°C POWER RATING	DERATING FACTOR ABOVE T _A = 25°C	T _A = 70°C POWER RATING	T _A = 85°C POWER RATING
DBV	309 mW	3.1 mW/°C	170 mW	123 mW
D	568 mW	5.7 mW/°C	313 mW	227 mW

recommended operating conditions

	MIN	MAX	UNIT
Input voltage, V _{I(INx)}	2.7	4	V
Input voltage, V _I at \overline{EN} and EN	0	4	V
Continuous output current, I _{O(IN1)}		500	mA
Continuous output current, I _{O(IN2)}		10 [‡]	mA
Operating virtual junction temperature, T _J	–40	85	°C

[‡] The device can deliver up to 220 mA at I_{O(IN2)}. However, operation at the higher current levels will result in greater voltage drop across the device, and greater voltage droop when switching between IN1 and IN2.



electrical characteristics over recommended operating junction temperature range,
V_{I(IN1)} = V_{I(IN2)} = 3.3 V, I_O = rated current (unless otherwise noted)

power switch

PARAMETER		TEST CONDITIONS†	MIN	TYP	MAX	UNIT
r _{DS(on)} On-state resistance	IN1-OUT	T _J = 25°C		250		mΩ
		T _J = 85°C		300	375	
	IN2-OUT	T _J = 25°C		1.3		Ω
		T _J = 85°C		1.5	2.1	

† Pulse-testing techniques maintain junction temperature close to ambient temperature; thermal effects must be taken into account separately.

enable input (\overline{EN} and EN)

PARAMETER		TEST CONDITIONS	MIN	TYP	MAX	UNIT	
V _{IH}	High-level input voltage	2.7 V ≤ V _{I(INx)} ≤ 4 V	2			V	
V _{IL}	Low-level input voltage	2.7 V ≤ V _{I(INx)} ≤ 4 V			0.8	V	
I _I	Input current	TPS2100	$\overline{EN} = 0\text{ V}$ or $\overline{EN} = V_{I(INx)}$		-0.5	0.5	μA
		TPS2101	EN = 0 V or EN = V _{I(INx)}		-0.5	0.5	μA

supply current

PARAMETER		TEST CONDITIONS		MIN	TYP	MAX	UNIT	
I _I	Supply current	TPS2100	$\overline{EN} = H,$	T _J = 25°C	0.75		μA	
			IN2 selected	-40°C ≤ T _J ≤ 85°C		1.5		
		TPS2101	$\overline{EN} = L,$	IN1 selected	T _J = 25°C	10		μA
					-40°C ≤ T _J ≤ 85°C		16	
			EN = L,	IN2 selected	T _J = 25°C	0.75		μA
					-40°C ≤ T _J ≤ 85°C		1.5	
EN = H,	IN1 selected	T _J = 25°C	10		μA			
		-40°C ≤ T _J ≤ 85°C		16				

TPS2100, TPS2101

V_{AUX} POWER-DISTRIBUTION SWITCHES

SLVS197D – JUNE 1999 – REVISED JUNE 2000

switching characteristics, T_J = 25°C, V_{I(IN1)} = V_{I(IN2)} = 3.3 V (unless otherwise noted)†

PARAMETER		TEST CONDITIONS†		MIN	TYP	MAX	UNIT
t _r	Output rise time	IN1-OUT	V _{I(IN2)} = 0	C _L = 1 μF, I _L = 500 mA	830		μs
				C _L = 10 μF, I _L = 500 mA	840		
				C _L = 1 μF, I _L = 10 mA	640		
		IN2-OUT	V _{I(IN1)} = 0	C _L = 1 μF, I _L = 10 mA	5.5		
				C _L = 10 μF, I _L = 10 mA	70		
				C _L = 1 μF, I _L = 1 mA	5.5		
t _f	Output fall time	IN1-OUT	V _{I(IN2)} = 0	C _L = 1 μF, I _L = 500 mA	8		μs
				C _L = 10 μF, I _L = 500 mA	93		
				C _L = 1 μF, I _L = 10 mA	23		
		IN2-OUT	V _{I(IN1)} = 0	C _L = 1 μF, I _L = 10 mA	690		
				C _L = 10 μF, I _L = 10 mA	6900		
				C _L = 1 μF, I _L = 1 mA	6900		
t _{PLH}	Propagation delay time, low-to-high output	IN1-OUT	V _{I(IN2)} = 0	C _L = 10 μF, I _L = 10 mA	75		μs
		IN2-OUT	V _{I(IN1)} = 0		2		
t _{PHL}	Propagation delay time, high-to-low output	IN1-OUT	V _{I(IN2)} = 0	C _L = 10 μF, I _L = 10 mA	3		μs
		IN2-OUT	V _{I(IN1)} = 0		370		

† All timing parameters refer to Figure 3.



PARAMETER MEASUREMENT INFORMATION

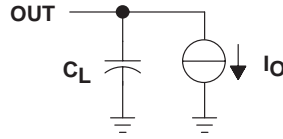

LOAD CIRCUIT

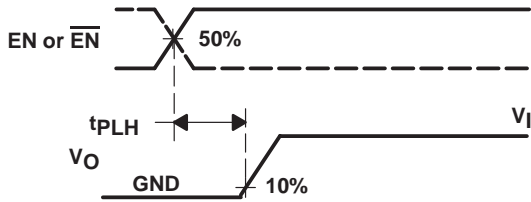

Propagation Delay Time, Low-to-High-Level Output

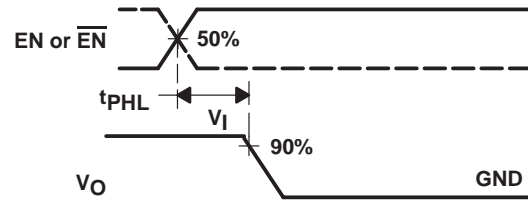

Propagation Delay Time, High-to-Low-Level Output

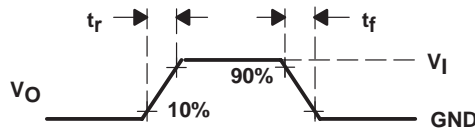

Rise/Fall Time

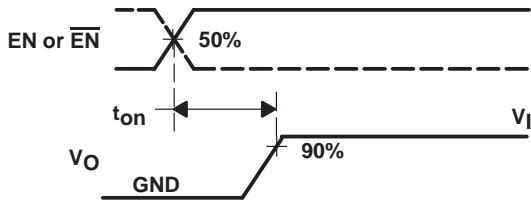

Turn-on Transition Time

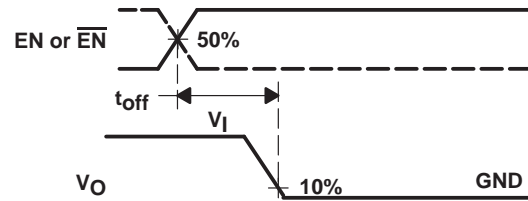

Turn-off Transition Time

WAVEFORMS

Figure 3. Test Circuit and Voltage Waveforms

Table of Timing Diagrams†

	FIGURE
Propagation Delay and Rise Time With 0.1- μ F Load, IN1	4
Propagation Delay and Rise Time With 0.1- μ F Load, IN2	5
Propagation Delay and Fall Time With 0.1- μ F Load, IN1	6
Propagation Delay and Fall Time With 0.1- μ F Load, IN2	7
Propagation Delay and Rise Time With 1- μ F Load, IN1	8
Propagation Delay and Rise Time With 1- μ F Load, IN2	9
Propagation Delay and Fall Time With 1- μ F Load, IN1	10
Propagation Delay and Fall Time With 1- μ F Load, IN2	11

† Waveforms shown in Figures 4–11 refer to TPS2100 at $T_J = 25^\circ\text{C}$

PARAMETER MEASUREMENT INFORMATION

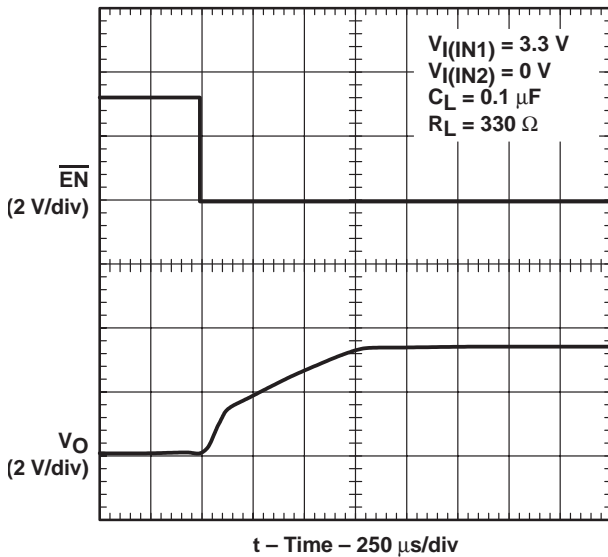

Figure 4. Propagation Delay and Rise Time With 0.1- μF Load, IN1

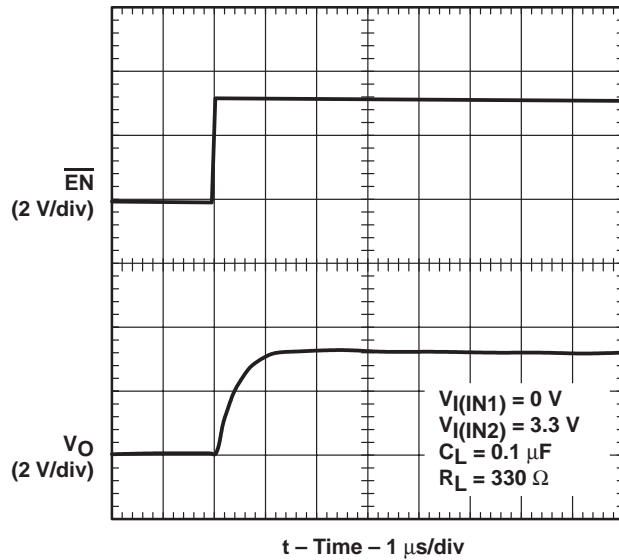

Figure 5. Propagation Delay and Fall Time With 0.1- μF Load, IN2

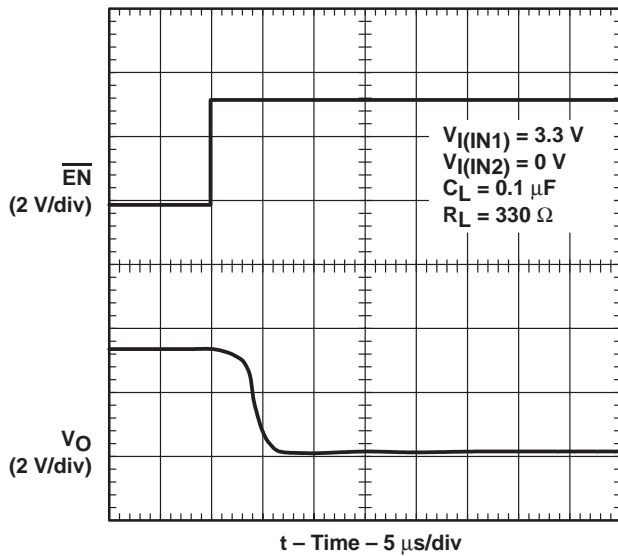

Figure 6. Propagation Delay and Fall Time With 0.1- μF Load, IN1

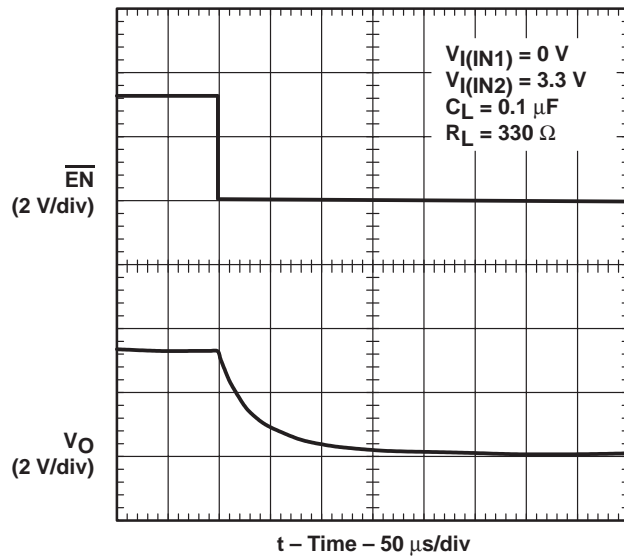

Figure 7. Propagation Delay and Fall Time With 0.1- μF Load, IN2

PARAMETER MEASUREMENT INFORMATION

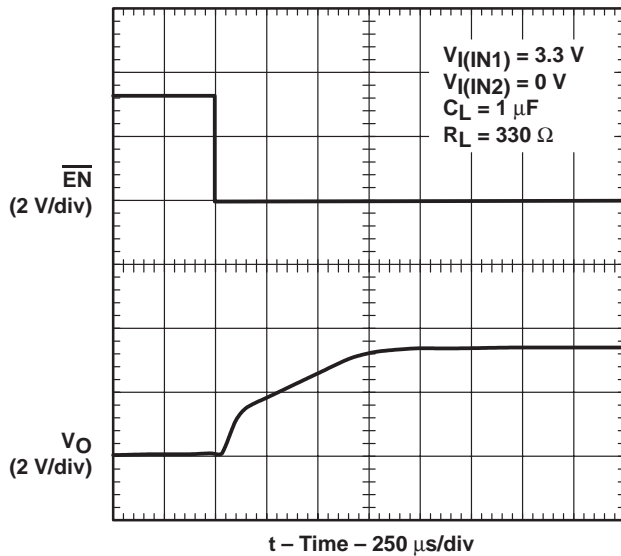

Figure 8. Propagation Delay and Rise Time With 1- μF Load, IN1

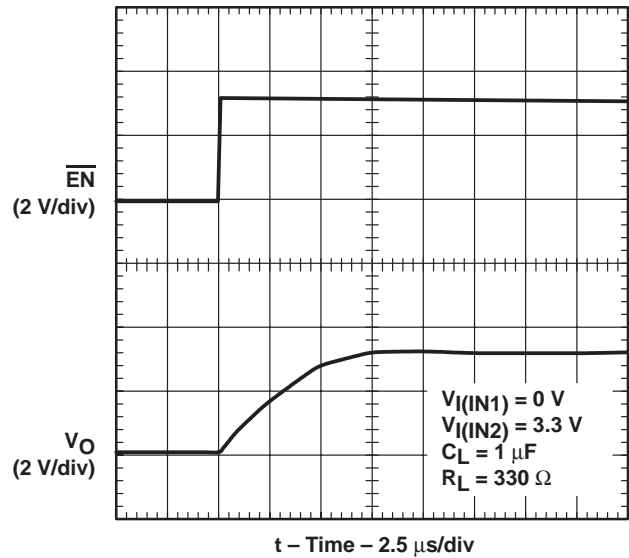

Figure 9. Propagation Delay and Rise Time With 1- μF Load, IN2

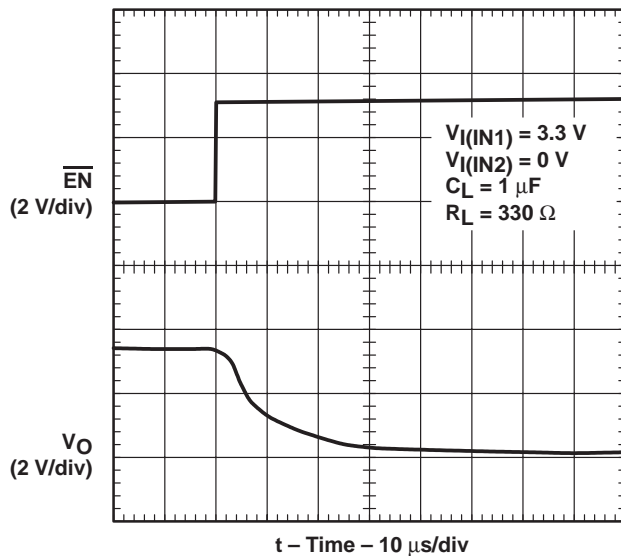

Figure 10. Propagation Delay and Fall Time With 1- μF Load, IN1

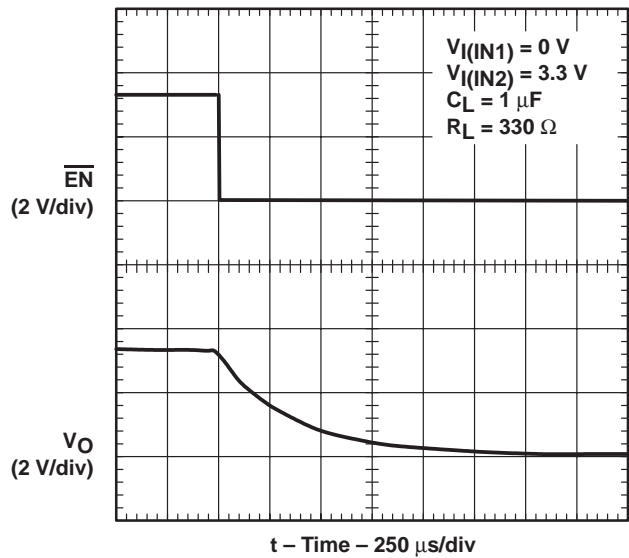

Figure 11. Propagation Delay and Fall Time With 1- μF Load, IN2

TPS2100, TPS2101 V_{AUX} POWER-DISTRIBUTION SWITCHES

SLVS197D – JUNE 1999 – REVISED JUNE 2000

TYPICAL CHARACTERISTICS

Table of Graphs

		FIGURE
IN1 Switch Rise Time	vs Output Current	12
IN2 Switch Fall Time	vs Output Current	13
IN1 Switch Fall Time	vs Output Current	14
IN2 Switch Fall Time	vs Output Current	15
Output Voltage Droop	vs Output Current When Output Is Switched From IN2 to IN1	16
Inrush Current	vs Output Capacitance	17
IN1 Supply Current	vs Junction Temperature (IN1 Enabled)	18
IN1 Supply Current	vs Junction Temperature (IN1 Disabled)	19
IN2 Supply Current	vs Junction Temperature (IN2 Enabled)	20
IN2 Supply Current	vs Junction Temperature (IN2 Disabled)	21
IN1-OUT On-State Resistance	vs Junction Temperature	22
IN2-OUT On-State Resistance	vs Junction Temperature	23

IN1 SWITCH RISE TIME
vs
OUTPUT CURRENT

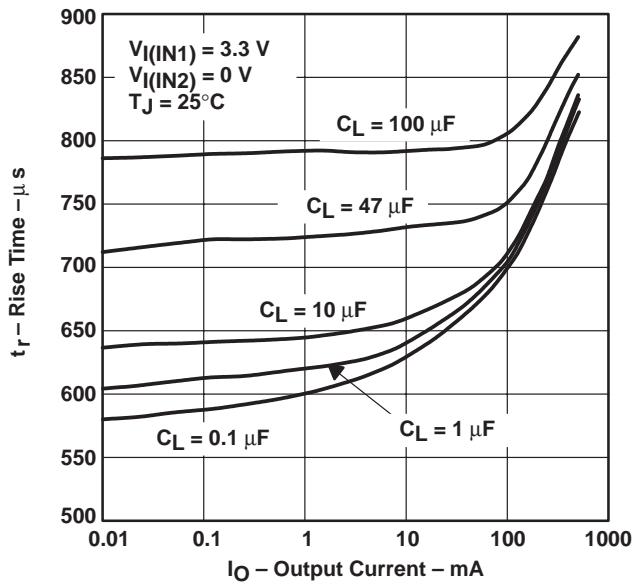

Figure 12

IN2 SWITCH RISE TIME
vs
OUTPUT CURRENT

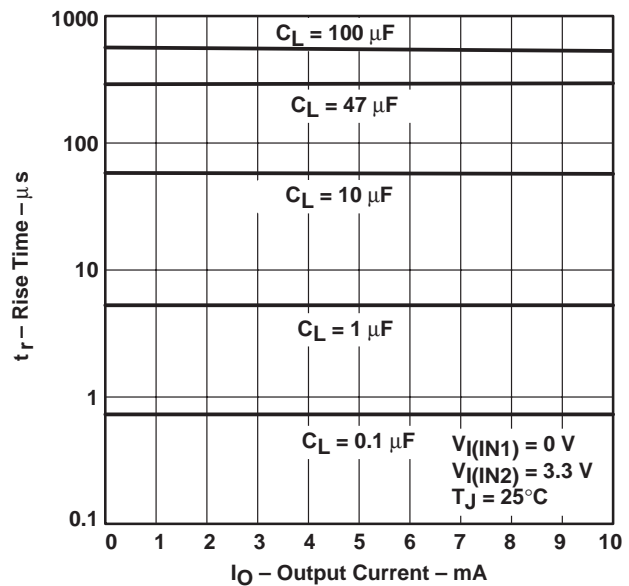
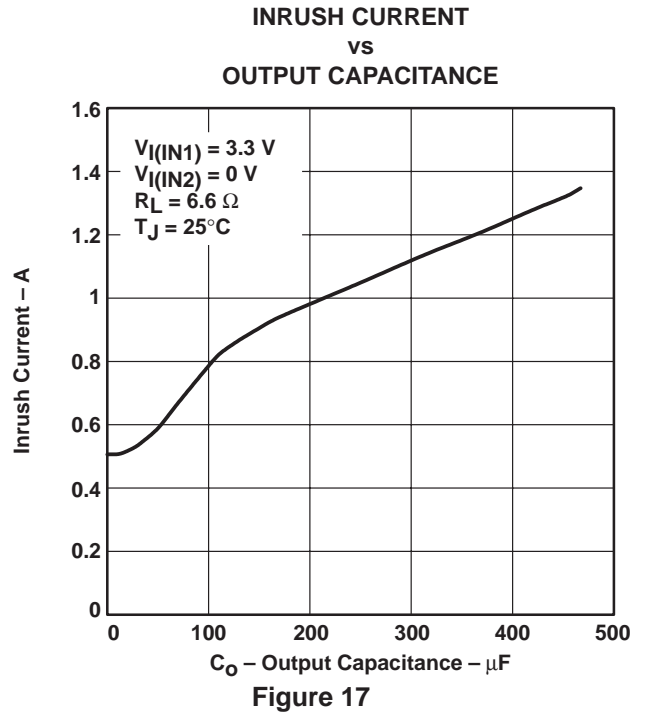
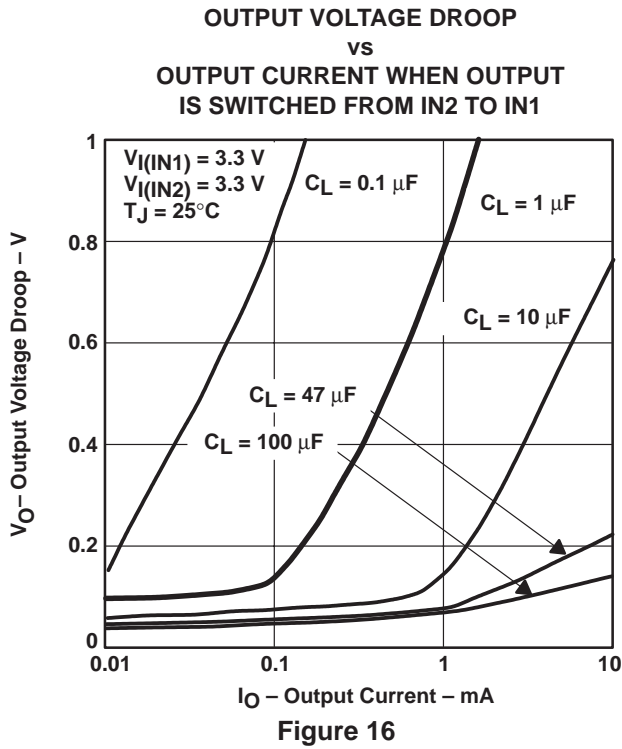
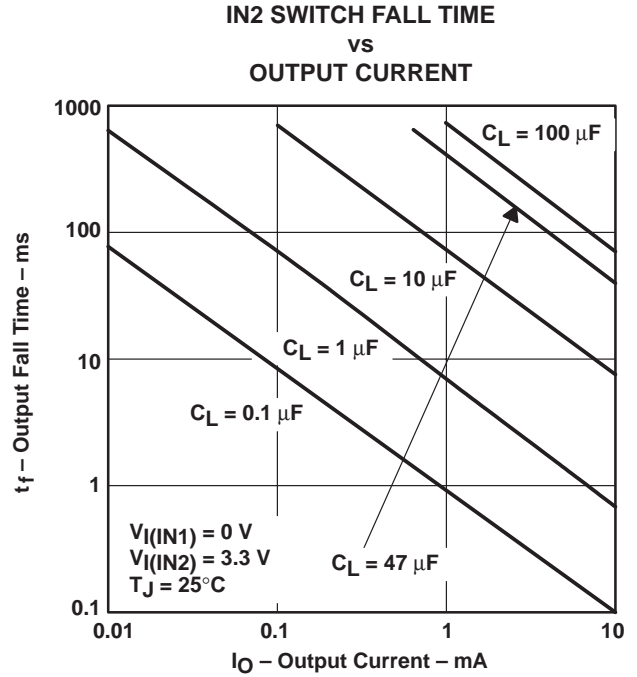
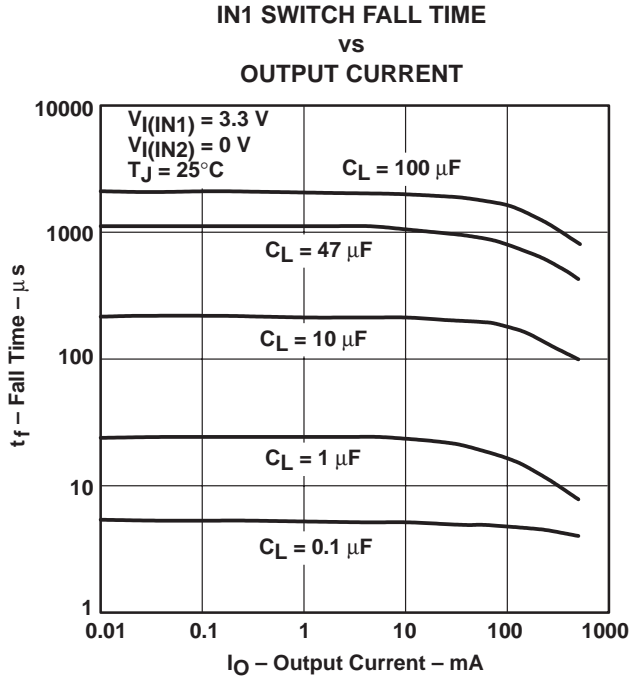

Figure 13

TYPICAL CHARACTERISTICS



TYPICAL CHARACTERISTICS

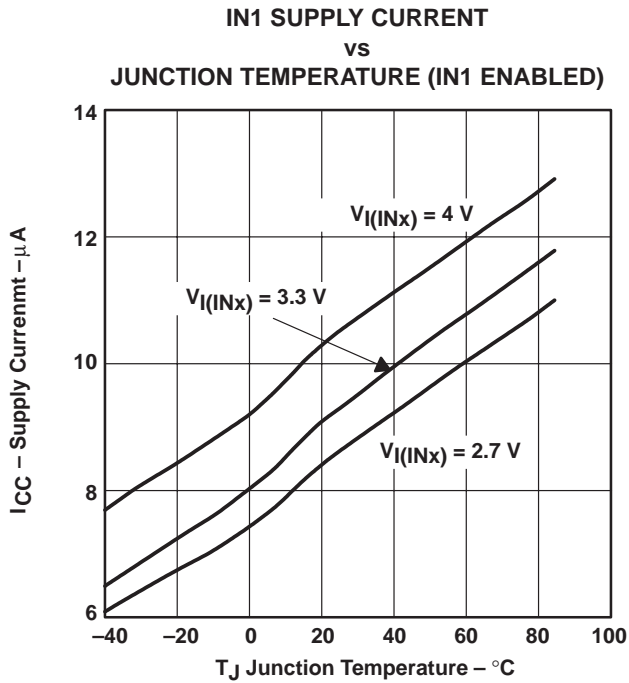

Figure 18

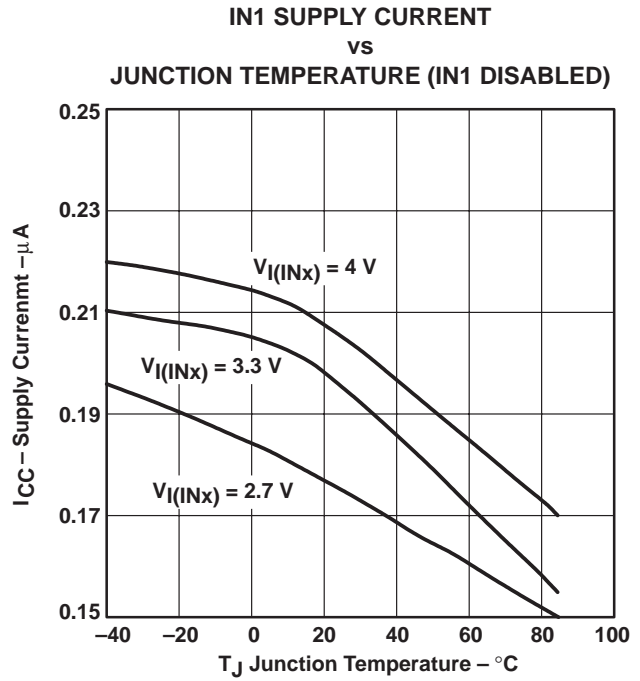

Figure 19

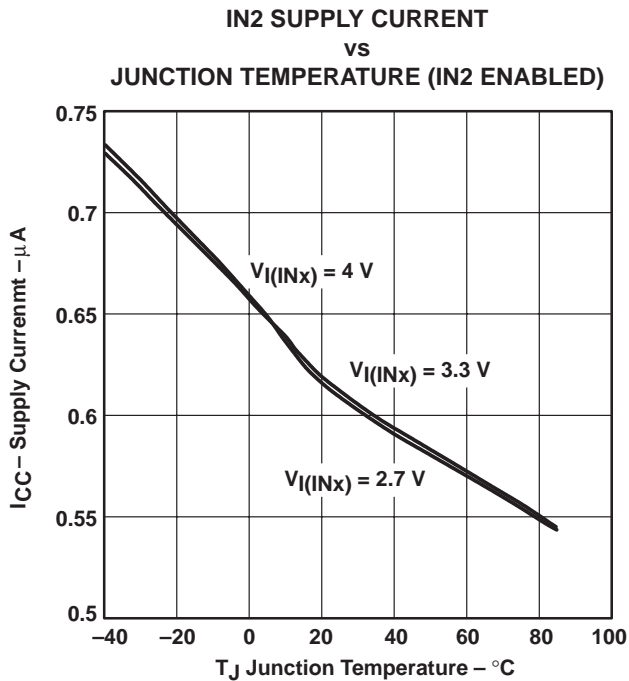

Figure 20

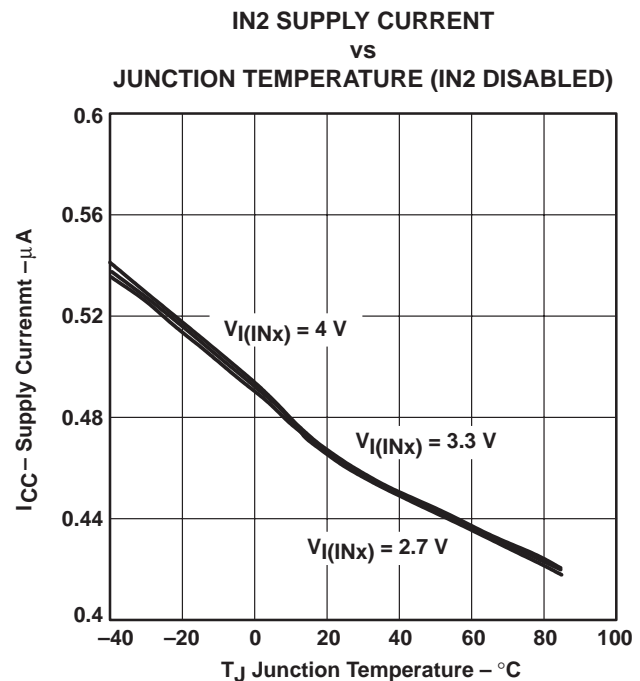

Figure 21

TYPICAL CHARACTERISTICS

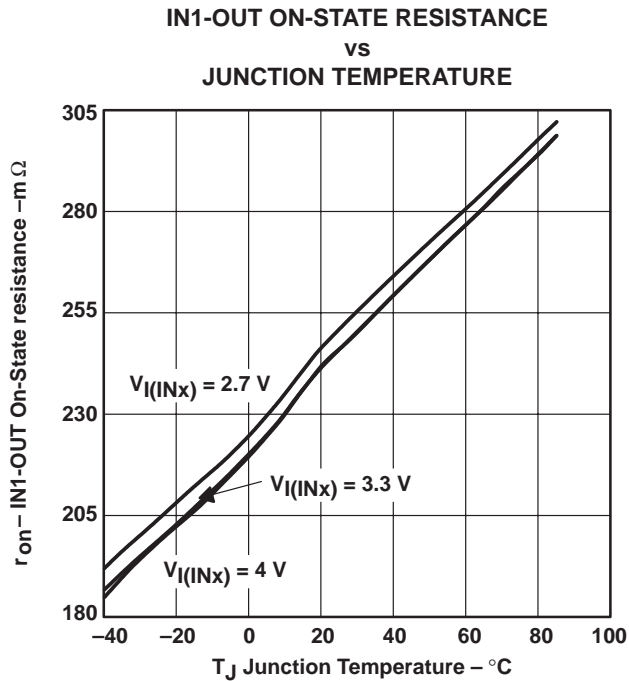

Figure 22

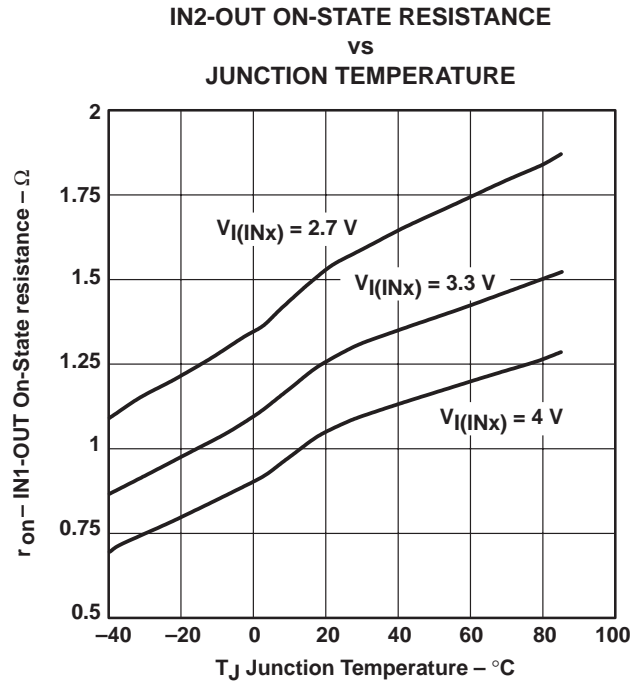

Figure 23

APPLICATION INFORMATION

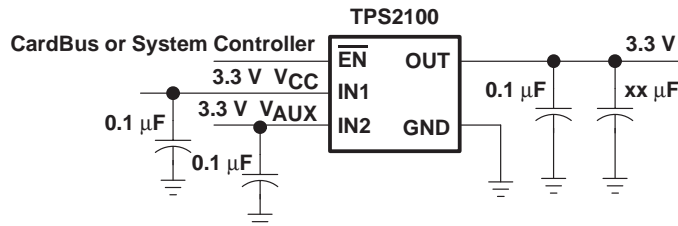

Figure 24. Typical Application

power supply considerations

A 0.01- μF to 0.1- μF ceramic bypass capacitor between IN and GND, close to the device is recommended. The output capacitor should be chosen based on the size of the load during the transition of the switch. A 47- μF capacitor is recommended for 10-mA loads. Typical output capacitors (xx μF , shown in Figure 24) required for a given load can be determined from Figure 16 which shows the output voltage droop when output is switched from IN2 to IN1. The output voltage droop is insignificant when output is switched from IN1 to IN2. Additionally, bypassing the output with a 0.01- μF to 0.1- μF ceramic capacitor improves the immunity of the device to short-circuit transients.

APPLICATION INFORMATION

power supply considerations (continued)

switch transition

The n-channel MOSFET on IN1 uses a charge-pump to create the gate-drive voltage, which gives the IN1 switch a rise time of approximately 1 ms. The p-channel MOSFET on IN2 has a simpler drive circuit that allows a rise time of approximately 8 μs. Because the device has two switches and a single enable pin, these rise times are seen as transition times, from IN1 to IN2, or IN2 to IN1, by the output. The controlled transition times help limit the surge currents seen by the power supply during switching.

thermal protection

Thermal protection provided on the IN1 switch prevents damage to the IC when heavy-overload or short-circuit faults are present for extended periods of time. The increased dissipation causes the junction temperature to rise to dangerously high levels. The protection circuit senses the junction temperature of the switch and shuts it off at approximately 125°C (T_J). The switch remains off until the junction temperature has dropped. The switch continues to cycle in this manner until the load fault or input power is removed.

undervoltage lockout

An undervoltage lockout function is provided to ensure that the power switch is in the off state at power-up. Whenever the input voltage falls below approximately 2 V, the power switch quickly turns off. This function facilitates the design of hot-insertion systems that may not have the capability to turn off the power switch before input power is removed. Upon reinsertion, the power switch will be turned on with a controlled rise time to reduce EMI and voltage overshoots.

power dissipation and junction temperature

The low on-resistance on the n-channel MOSFET allows small surface-mount packages, such as SOIC, to pass large currents. The thermal resistances of these packages are high compared to that of power packages; it is good design practice to check power dissipation and junction temperature. First, find r_{on} at the input voltage, and operating temperature. As an initial estimate, use the highest operating ambient temperature of interest and read r_{on} from Figure 22 or Figure 23. Next calculate the power dissipation using:

$$P_D = r_{on} \times I^2$$

Finally, calculate the junction temperature:

$$T_J = P_D \times R_{\theta JA} + T_A$$

Where:

T_A = Ambient temperature

R_{θJA} = Thermal resistance

Compare the calculated junction temperature with the initial estimate. If they do not agree within a few degrees, repeat the calculation using the calculated value as the new estimate. Two or three iterations are generally sufficient to obtain a reasonable answer.

ESD protection

All TPS2100 and TPS2101 terminals incorporate ESD-protection circuitry designed to withstand a 2-kV human-body-model discharge as defined in MIL-STD-883C.

MECHANICAL DATA

DBV (R-PDSO-G5)

PLASTIC SMALL-OUTLINE

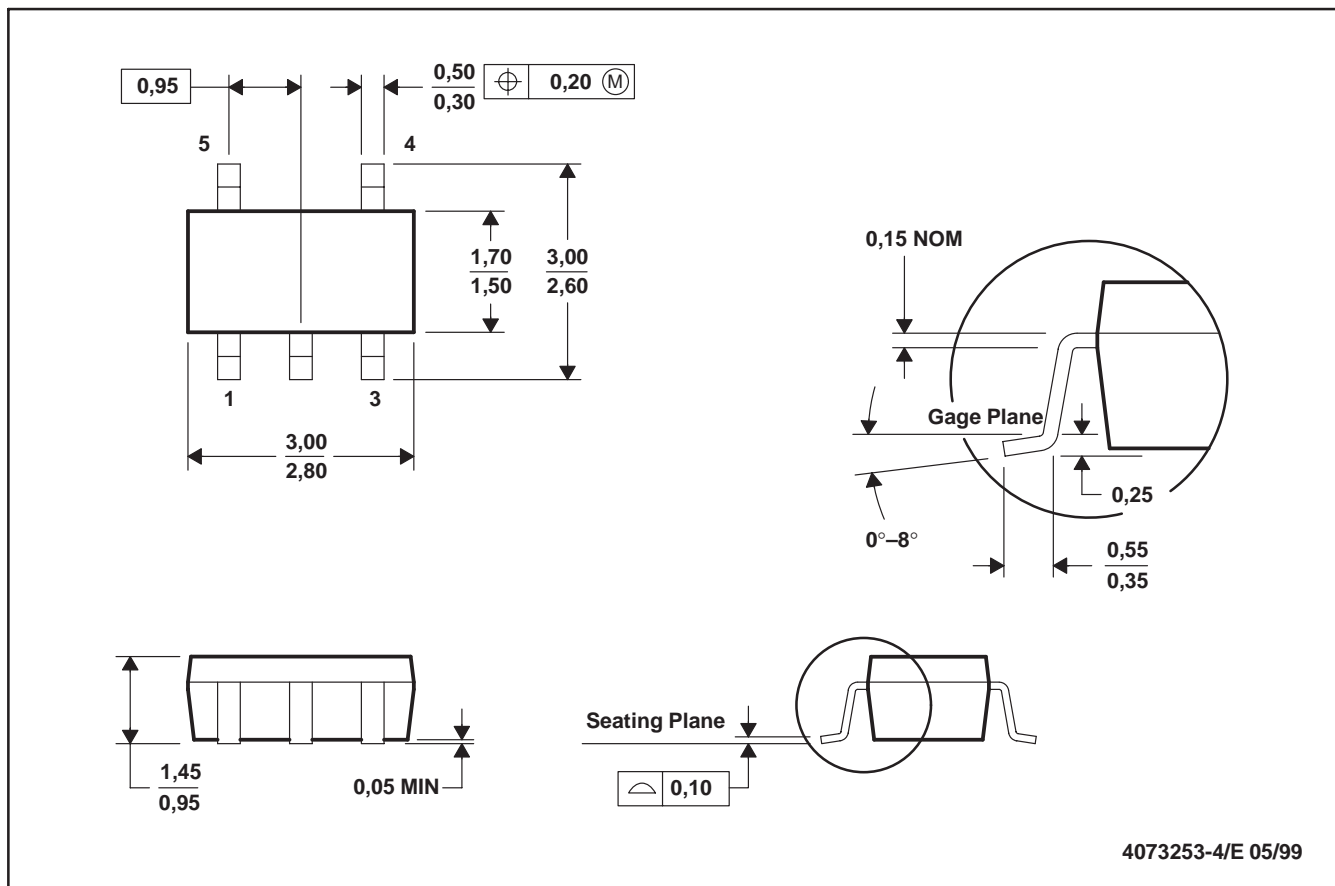

- NOTES: A. All linear dimensions are in millimeters.
 B. This drawing is subject to change without notice.
 C. Body dimensions do not include mold flash or protrusion.
 D. Falls within JEDEC MO-178

TPS2100, TPS2101 V_{AUX} POWER-DISTRIBUTION SWITCHES

SLVS197D – JUNE 1999 – REVISED JUNE 2000

MECHANICAL DATA

D (R-PDSO-G**)

PLASTIC SMALL-OUTLINE PACKAGE

14 PINS SHOWN

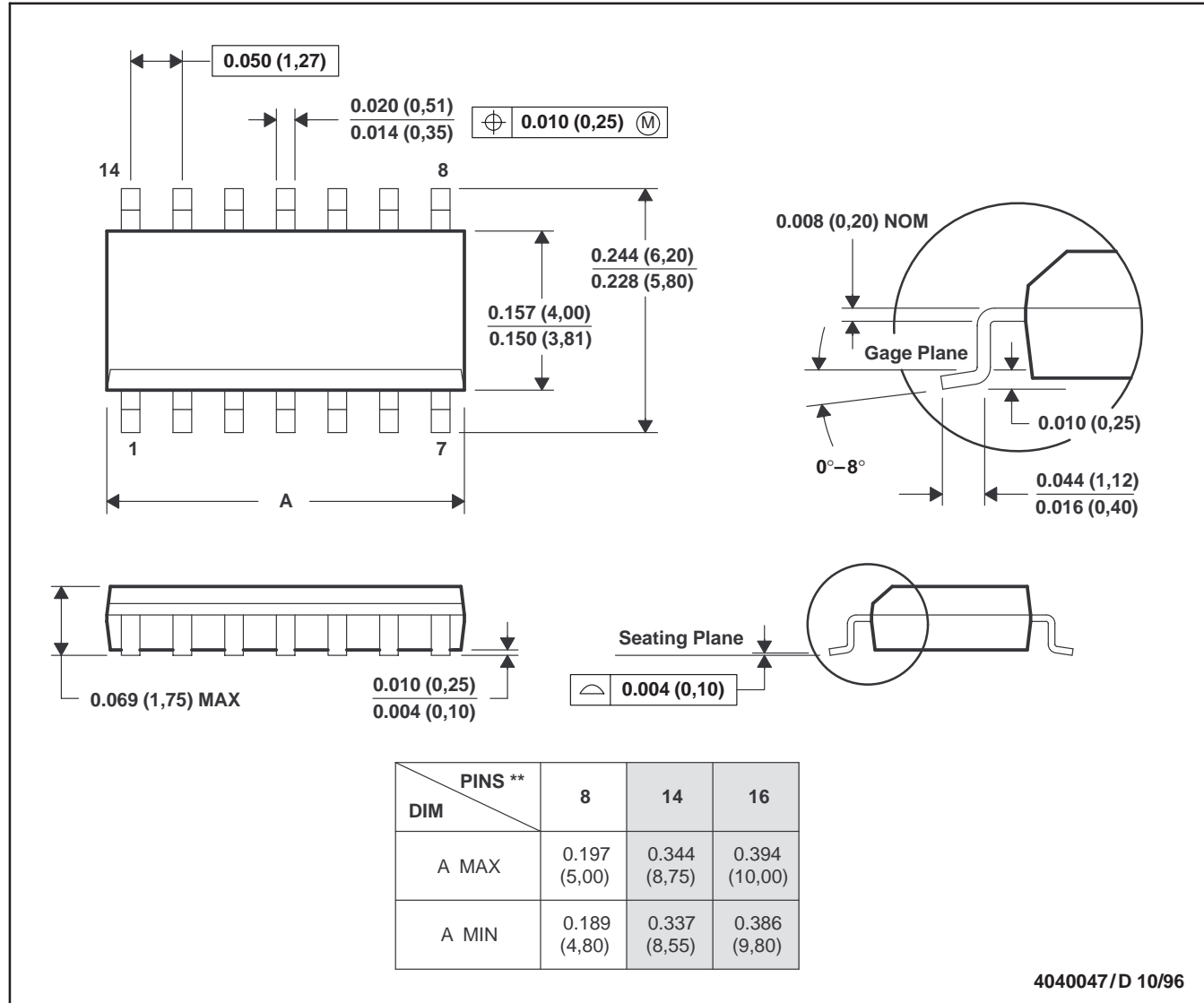

- NOTES: A. All linear dimensions are in inches (millimeters).
 B. This drawing is subject to change without notice.
 C. Body dimensions do not include mold flash or protrusion, not to exceed 0.006 (0,15).
 D. Falls within JEDEC MS-012

PACKAGING INFORMATION

Orderable Device	Status (1)	Package Type	Package Drawing	Pins	Package Qty	Eco Plan (2)	Lead finish/ Ball material (6)	MSL Peak Temp (3)	Op Temp (°C)	Device Marking (4/5)	Samples
TPS2100DBVR	ACTIVE	SOT-23	DBV	5	3000	RoHS & Green	NIPDAU	Level-1-260C-UNLIM	-40 to 85	PBYI	Samples
TPS2100DBVT	ACTIVE	SOT-23	DBV	5	250	RoHS & Green	NIPDAU	Level-1-260C-UNLIM	-40 to 85	PBYI	Samples
TPS2101D	ACTIVE	SOIC	D	8	75	RoHS & Green	NIPDAU	Level-1-260C-UNLIM	-40 to 85	2101	Samples
TPS2101DBVR	ACTIVE	SOT-23	DBV	5	3000	RoHS & Green	NIPDAU	Level-1-260C-UNLIM	-40 to 85	PBZI	Samples
TPS2101DBVT	ACTIVE	SOT-23	DBV	5	250	RoHS & Green	NIPDAU	Level-1-260C-UNLIM	-40 to 85	PBZI	Samples

(1) The marketing status values are defined as follows:

ACTIVE: Product device recommended for new designs.

LIFEBUY: TI has announced that the device will be discontinued, and a lifetime-buy period is in effect.

NRND: Not recommended for new designs. Device is in production to support existing customers, but TI does not recommend using this part in a new design.

PREVIEW: Device has been announced but is not in production. Samples may or may not be available.

OBSELETE: TI has discontinued the production of the device.

(2) **RoHS:** TI defines "RoHS" to mean semiconductor products that are compliant with the current EU RoHS requirements for all 10 RoHS substances, including the requirement that RoHS substance do not exceed 0.1% by weight in homogeneous materials. Where designed to be soldered at high temperatures, "RoHS" products are suitable for use in specified lead-free processes. TI may reference these types of products as "Pb-Free".

RoHS Exempt: TI defines "RoHS Exempt" to mean products that contain lead but are compliant with EU RoHS pursuant to a specific EU RoHS exemption.

Green: TI defines "Green" to mean the content of Chlorine (Cl) and Bromine (Br) based flame retardants meet JS709B low halogen requirements of <=1000ppm threshold. Antimony trioxide based flame retardants must also meet the <=1000ppm threshold requirement.

(3) MSL, Peak Temp. - The Moisture Sensitivity Level rating according to the JEDEC industry standard classifications, and peak solder temperature.

(4) There may be additional marking, which relates to the logo, the lot trace code information, or the environmental category on the device.

(5) Multiple Device Markings will be inside parentheses. Only one Device Marking contained in parentheses and separated by a "~" will appear on a device. If a line is indented then it is a continuation of the previous line and the two combined represent the entire Device Marking for that device.

(6) Lead finish/Ball material - Orderable Devices may have multiple material finish options. Finish options are separated by a vertical ruled line. Lead finish/Ball material values may wrap to two lines if the finish value exceeds the maximum column width.

Important Information and Disclaimer: The information provided on this page represents TI's knowledge and belief as of the date that it is provided. TI bases its knowledge and belief on information provided by third parties, and makes no representation or warranty as to the accuracy of such information. Efforts are underway to better integrate information from third parties. TI has taken and continues to take reasonable steps to provide representative and accurate information but may not have conducted destructive testing or chemical analysis on incoming materials and chemicals. TI and TI suppliers consider certain information to be proprietary, and thus CAS numbers and other limited information may not be available for release.

In no event shall TI's liability arising out of such information exceed the total purchase price of the TI part(s) at issue in this document sold by TI to Customer on an annual basis.

TAPE AND REEL INFORMATION

QUADRANT ASSIGNMENTS FOR PIN 1 ORIENTATION IN TAPE



*All dimensions are nominal

Device	Package Type	Package Drawing	Pins	SPQ	Reel Diameter (mm)	Reel Width W1 (mm)	A0 (mm)	B0 (mm)	K0 (mm)	P1 (mm)	W (mm)	Pin1 Quadrant
TPS2100DBVR	SOT-23	DBV	5	3000	180.0	9.0	3.15	3.2	1.4	4.0	8.0	Q3
TPS2100DBVT	SOT-23	DBV	5	250	180.0	9.0	3.15	3.2	1.4	4.0	8.0	Q3
TPS2101DBVR	SOT-23	DBV	5	3000	180.0	9.0	3.15	3.2	1.4	4.0	8.0	Q3
TPS2101DBVT	SOT-23	DBV	5	250	180.0	9.0	3.15	3.2	1.4	4.0	8.0	Q3

TAPE AND REEL BOX DIMENSIONS

*All dimensions are nominal

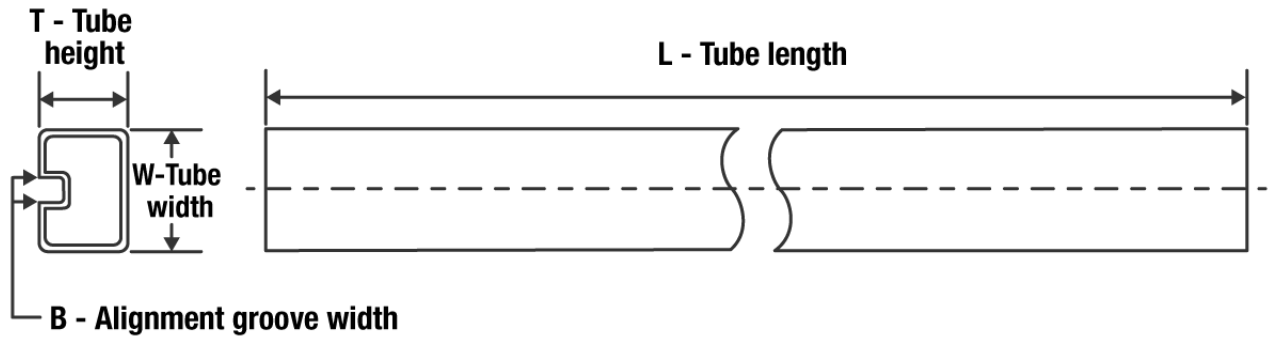
Device	Package Type	Package Drawing	Pins	SPQ	Length (mm)	Width (mm)	Height (mm)
TPS2100DBVR	SOT-23	DBV	5	3000	182.0	182.0	20.0
TPS2100DBVT	SOT-23	DBV	5	250	182.0	182.0	20.0
TPS2101DBVR	SOT-23	DBV	5	3000	182.0	182.0	20.0
TPS2101DBVT	SOT-23	DBV	5	250	182.0	182.0	20.0

TUBE

*All dimensions are nominal

Device	Package Name	Package Type	Pins	SPQ	L (mm)	W (mm)	T (μm)	B (mm)
TPS2101D	D	SOIC	8	75	505.46	6.76	3810	4

IMPORTANT NOTICE AND DISCLAIMER

TI PROVIDES TECHNICAL AND RELIABILITY DATA (INCLUDING DATA SHEETS), DESIGN RESOURCES (INCLUDING REFERENCE DESIGNS), APPLICATION OR OTHER DESIGN ADVICE, WEB TOOLS, SAFETY INFORMATION, AND OTHER RESOURCES "AS IS" AND WITH ALL FAULTS, AND DISCLAIMS ALL WARRANTIES, EXPRESS AND IMPLIED, INCLUDING WITHOUT LIMITATION ANY IMPLIED WARRANTIES OF MERCHANTABILITY, FITNESS FOR A PARTICULAR PURPOSE OR NON-INFRINGEMENT OF THIRD PARTY INTELLECTUAL PROPERTY RIGHTS.

These resources are intended for skilled developers designing with TI products. You are solely responsible for (1) selecting the appropriate TI products for your application, (2) designing, validating and testing your application, and (3) ensuring your application meets applicable standards, and any other safety, security, regulatory or other requirements.

These resources are subject to change without notice. TI grants you permission to use these resources only for development of an application that uses the TI products described in the resource. Other reproduction and display of these resources is prohibited. No license is granted to any other TI intellectual property right or to any third party intellectual property right. TI disclaims responsibility for, and you will fully indemnify TI and its representatives against, any claims, damages, costs, losses, and liabilities arising out of your use of these resources.

TI's products are provided subject to [TI's Terms of Sale](#) or other applicable terms available either on ti.com or provided in conjunction with such TI products. TI's provision of these resources does not expand or otherwise alter TI's applicable warranties or warranty disclaimers for TI products.

TI objects to and rejects any additional or different terms you may have proposed.

Mailing Address: Texas Instruments, Post Office Box 655303, Dallas, Texas 75265
Copyright © 2022, Texas Instruments Incorporated