

# TPS22965x-Q1 5.5-V, 4-A, 16-mΩ On-Resistance Automotive Load Switch

## 1 Features

- Qualified for automotive applications
  - AEC-Q100 qualified
  - Device temperature grade 2:  $-40^{\circ}\text{C}$  to  $+105^{\circ}\text{C}$  (TPS22965-Q1, TPS22965N-Q1)
  - Device temperature grade 1:  $-40^{\circ}\text{C}$  to  $+125^{\circ}\text{C}$  (TPS22965W-Q1, TPS22965NW-Q1)
  - Device HBM ESD classification level 3A
  - Device CDM ESD classification level C6
- Functional Safety-Capable
  - Documentation available to aid functional safety system design
- Integrated single channel load switch
- Input voltage range: 0.8 V to 5.5 V
- Ultra-low on resistance ( $R_{\text{ON}}$ )
  - $R_{\text{ON}} = 16\text{ m}\Omega$  at  $V_{\text{IN}} = 5\text{ V}$  ( $V_{\text{BIAS}} = 5\text{ V}$ )
  - $R_{\text{ON}} = 16\text{ m}\Omega$  at  $V_{\text{IN}} = 3.6\text{ V}$  ( $V_{\text{BIAS}} = 5\text{ V}$ )
  - $R_{\text{ON}} = 16\text{ m}\Omega$  at  $V_{\text{IN}} = 1.8\text{ V}$  ( $V_{\text{BIAS}} = 5\text{ V}$ )
- 4-A maximum continuous switch current
- Low quiescent current (50  $\mu\text{A}$ )
- Low control input threshold enables use of 1.2-, 1.8-, 2.5- and 3.3-V logic
- Configurable rise time
- Quick Output Discharge (QOD) (TPS22965-Q1 and TPS22965W-Q1 only)
- WSON 8-pin package with thermal pad

## 2 Applications

- Automotive electronics
- Infotainment
- ADAS (Advanced Driver Assistance Systems)

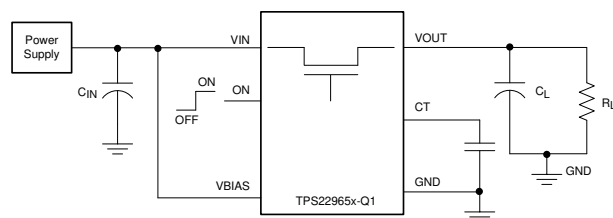

**Simplified Schematic**

## 3 Description

The TPS22965x-Q1 is a small, ultra-low- $R_{\text{ON}}$ , single-channel load switch with controlled turn-on. The device contains an N-channel MOSFET that can operate over an input voltage range of 0.8 V to 5.5 V and can support a maximum continuous current of 4 A. The  $V_{\text{OUT}}$  rise time is configurable so that inrush current can be reduced. The TPS22965-Q1 and TPS22965W-Q1 devices include a 225- $\Omega$  on-chip load resistor for quick output discharge when the switch is turned off.

The TPS22965x-Q1 devices are available in a small, space-saving 2-mm  $\times$  2-mm 8-pin WSON package (DSG0008A) with integrated thermal pad allowing for high power dissipation. The TPS22965-Q1 and TPS22965N-Q1 devices are characterized for operation over the free-air temperature range of  $-40^{\circ}\text{C}$  to  $105^{\circ}\text{C}$ . Furthermore, the TPS22965W-Q1 and TPS22965NW-Q1 devices feature wettable flanks in the same WSON package (DSG0008B) and it is characterized for operation over the free-air temperature range of  $-40^{\circ}\text{C}$  to  $+125^{\circ}\text{C}$ .

### Device Information (1)

| PART NUMBER   | PACKAGE  | BODY SIZE (NOM)          |
|---------------|----------|--------------------------|
| TPS22965-Q1   | DSG0008A | 2.00 mm $\times$ 2.00 mm |
| TPS22965N-Q1  | WSON (8) |                          |
| TPS22965W-Q1  | DSG0008B |                          |
| TPS22965NW-Q1 | WSON (8) |                          |

- (1) For all available packages, see the orderable addendum at the end of the data sheet.

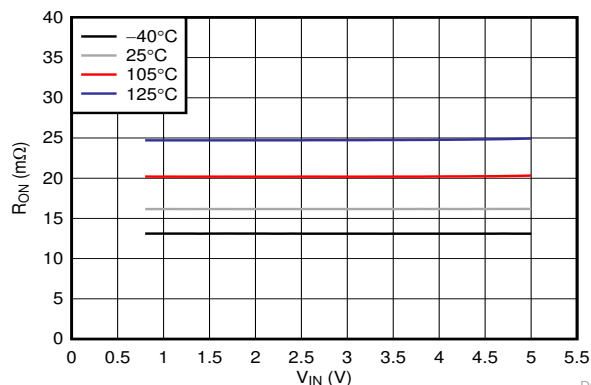

**$R_{\text{ON}}$  vs  $V_{\text{IN}}$  ( $V_{\text{BIAS}} = 5\text{ V}$ ,  $I_{\text{OUT}} = -200\text{ mA}$ )**

D008



## Table of Contents

|   |    |  |    |
|---|----|--|----|
| <b>1 Features</b> .....   | 1  | 9.3 Feature Description.....                                     | 17 |
| <b>2 Applications</b> .....                                     | 1  | 9.4 Device Functional Modes.....                                 | 17 |
| <b>3 Description</b> .....                                      | 1  | <b>10 Application and Implementation</b> .....                   | 18 |
| <b>4 Revision History</b> .....                                 | 2  | 10.1 Application Information.....                                | 18 |
| <b>5 Device Comparison Table</b> .....                          | 3  | 10.2 Typical Application.....                                    | 19 |
| <b>6 Pin Configuration and Functions</b> .....                  | 3  | <b>11 Power Supply Recommendations</b> .....                     | 21 |
| <b>7 Specifications</b> .....                                   | 4  | <b>12 Layout</b> .....   | 21 |
| 7.1 Absolute Maximum Ratings.....                               | 4  | 12.1 Layout Guidelines.....                                      | 21 |
| 7.2 ESD Ratings.....  | 4  | 12.2 Layout Example.....   | 21 |
| 7.3 Recommended Operating Conditions.....                       | 4  | 12.3 Thermal Consideration.....                                  | 21 |
| 7.4 Thermal Information.....                                    | 5  | <b>13 Device and Documentation Support</b> .....                 | 22 |
| 7.5 Electrical Characteristics— $V_{BIAS} = 5\text{ V}$ .....   | 5  | 13.1 Documentation Support.....                                  | 22 |
| 7.6 Electrical Characteristics— $V_{BIAS} = 2.5\text{ V}$ ..... | 7  | 13.2 Receiving Notification of Documentation Updates.....        | 22 |
| 7.7 Switching Characteristics.....                              | 9  | 13.3 Support Resources.....                                      | 22 |
| 7.8 Typical Characteristics.....                                | 10 | 13.4 Trademarks.....   | 22 |
| <b>8 Parameter Measurement Information</b> .....                | 15 | 13.5 Electrostatic Discharge Caution.....                        | 22 |
| <b>9 Detailed Description</b> .....                             | 16 | 13.6 Glossary.....   | 22 |
| 9.1 Overview.....   | 16 | <b>14 Mechanical, Packaging, and Orderable Information</b> ..... | 22 |
| 9.2 Functional Block Diagram.....                               | 16 |  |    |

## 4 Revision History

NOTE: Page numbers for previous revisions may differ from page numbers in the current version.

| Changes from Revision D (December 2019) to Revision E (July 2022)  | Page |
|--|------|
| • Updated the numbering format for tables, figures and cross-references throughout the document .....  | 1    |
| • Added the word “Automotive” to the document title .....  | 1    |
| • Updated the <i>ESD Ratings</i> table for automotive devices.....   | 4    |
| • Added line item in the <i>Recommended Operating Conditions</i> table for VIL voltage at $V_{BIAS} = 2\text{ V}$ to $2.5\text{ V}$ .....                                  | 4    |
| • Added line item in <i>Electrical Characteristics—<math>V_{BIAS} = 2\text{ V}</math> to <math>2.5\text{ V}</math></i> for QOD resistance at $V_{BIAS} = 2\text{ V}$ ..... | 7    |
| • Expanded $V_{BIAS}$ minimum rating from $2.5\text{ V}$ to $2\text{ V}$ .....   | 7    |
| Changes from Revision C (September 2016) to Revision D (December 2019)   | Page |
| • Added Functional safety capable link to the <i>Features</i> section .....  | 1    |
| Changes from Revision B (December 2015) to Revision C (September 2016)   | Page |
| • Added package designators in the <i>Description</i> section and <i>Thermal Information</i> table.....  | 1    |
| Changes from Revision A (June 2015) to Revision B (December 2015)  | Page |
| • Updated status of TPS22965W-Q1 part to ACTIVE.....   | 1    |
| • Added $125^{\circ}\text{C}$ temperature performance to typical AC timing parameters.....   | 12   |
| Changes from Revision * (April 2014) to Revision A (June 2015)   | Page |
| • Added TPS22965N-Q1 part number. ....   | 1    |
| • Updated Thermal Information table.....   | 5    |
| • Updated typical AC timing parameters (tables, graphs and scope captures) .....   | 12   |

## 5 Device Comparison Table

| DEVICE        | R <sub>ON</sub> AT 3.3 V (TYP) | QUICK OUTPUT DISCHARGE | PACKAGE WITH WETTABLE FLANKS | MAXIMUM OUTPUT CURRENT | TEMPERATURE RANGE |
|---------------|--------------------------------|------------------------|------------------------------|------------------------|-------------------|
| TPS22965-Q1   | 16 mΩ                          | Yes                    | No                           | 4 A                    | –40°C to +105°C   |
| TPS22965N-Q1  | 16 mΩ                          | No                     | No                           | 4 A                    | –40°C to +105°C   |
| TPS22965W-Q1  | 16 mΩ                          | Yes                    | Yes                          | 4 A                    | –40°C to +125°C   |
| TPS22965NW-Q1 | 16 mΩ                          | No                     | Yes                          | 4 A                    | –40°C to +125°C   |

## 6 Pin Configuration and Functions

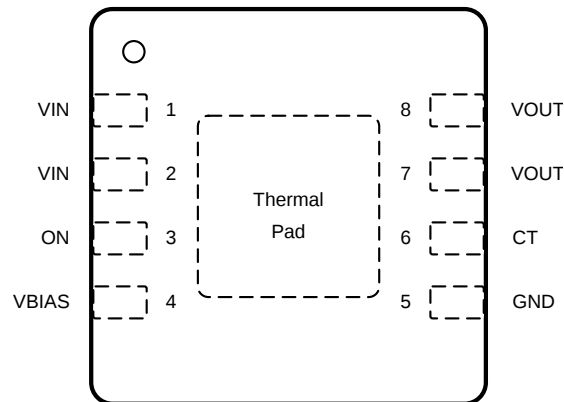

Figure 6-1. DSG Package 8-Pin WSON with Exposed Thermal Pad Top View

Table 6-1. Pin Functions

| PIN |             | I/O | DESCRIPTION  |
|-----|-------------|-----|--|
| NO. | NAME        |     |  |
| 1   | VIN         | I   | Switch input. Input bypass capacitor recommended for minimizing V <sub>IN</sub> dip. Must be connected to Pin 1 and Pin 2. See the <a href="#">Application and Implementation</a> section for more information |
| 2   |             |     |  |
| 3   | ON          | I   | Active high switch control input. Do not leave floating  |
| 4   | VBIAS       | I   | Bias voltage. Power supply to the device. Recommended voltage range for this pin is 2 V to 5.5 V. See the <a href="#">Application and Implementation</a> section for more information                          |
| 5   | GND         | —   | Device ground  |
| 6   | CT          | O   | Switch slew rate control. Can be left floating. See the <a href="#">Application and Implementation</a> section for more information  |
| 7   | VOUT        | O   | Switch output  |
| 8   |             |     |  |
| —   | Thermal pad | —   | Thermal pad (exposed center pad) to alleviate thermal stress. Tie to GND. See the <a href="#">Layout</a> section for layout guidelines   |

## 7 Specifications

### 7.1 Absolute Maximum Ratings

over operating free-air temperature range (unless otherwise noted)<sup>(1) (2)</sup>

|                   |  | MIN  | MAX | UNIT <sup>(2)</sup> |
|-------------------|--|------|-----|---------------------|
| V <sub>IN</sub>   | Input voltage  | -0.3 | 6   | V                   |
| V <sub>OUT</sub>  | Output voltage   | -0.3 | 6   | V                   |
| V <sub>BIAS</sub> | Bias voltage   | -0.3 | 6   | V                   |
| V <sub>ON</sub>   | On voltage   | -0.3 | 6   | V                   |
| I <sub>MAX</sub>  | Maximum continuous switch current                            |      | 4   | A                   |
| I <sub>PLS</sub>  | Maximum pulsed switch current, pulse < 300 μs, 2% duty cycle |      | 6   | A                   |
| T <sub>J</sub>    | Maximum junction temperature                                 |      | 150 | °C                  |
| T <sub>STG</sub>  | Storage temperature  | -65  | 150 | °C                  |

- (1) Stresses beyond those listed under *Absolute Maximum Ratings* may cause permanent damage to the device. These are stress ratings only, which do not imply functional operation of the device at these or any other conditions beyond those indicated under *Recommended Operating Conditions*. Exposure to absolute-maximum-rated conditions for extended periods may affect device reliability.
- (2) All voltage values are with respect to network ground pin.

### 7.2 ESD Ratings

|                    |                         | VALUE  | UNIT |
|--------------------|-------------------------|--|------|
| V <sub>(ESD)</sub> | Electrostatic discharge | Human body model (HBM), per AEC Q100-002 <sup>(1)</sup><br>HBM classification level 3A | V    |
|                    |                         | Charged device model (CDM), per AEC Q100-011<br>CDM classification level C6            |      |

- (1) AEC Q100-002 indicates that HBM stressing shall be in accordance with the ANSI/ESDA/JEDEC JS-001 specification.

### 7.3 Recommended Operating Conditions

over operating free-air temperature range (unless otherwise noted)

|                   |   |                                    | MIN              | MAX               | UNIT |
|-------------------|---|------------------------------------|------------------|-------------------|------|
| V <sub>IN</sub>   | Input voltage                                 |                                    | 0.8              | V <sub>BIAS</sub> | V    |
| V <sub>BIAS</sub> | Bias voltage                                  |                                    | 2                | 5.5               | V    |
| V <sub>ON</sub>   | ON voltage                                    |                                    | 0                | 5.5               | V    |
| V <sub>OUT</sub>  | Output voltage                                |                                    |                  | V <sub>IN</sub>   | V    |
| V <sub>IH</sub>   | High-level input voltage, ON                  | V <sub>BIAS</sub> = 2.5 V to 5.5 V | 1.2              | 5.5               | V    |
| V <sub>IL</sub>   | Low-level input voltage, ON                   | V <sub>BIAS</sub> = 2.5 V to 5.5 V | 0                | 0.5               | V    |
|                   |   | V <sub>BIAS</sub> = 2 V to 2.5 V   | 0                | 0.45              | V    |
| C <sub>IN</sub>   | Input capacitor                               |                                    | 1 <sup>(1)</sup> |                   | μF   |
| T <sub>A</sub>    | Operating free-air temperature <sup>(2)</sup> | TPS22965N-Q1, TPS22965-Q1          | -40              | 105               | °C   |
|                   |   | TPS22965NW-Q1, TPS22965W-Q1        | -40              | 125               |      |

- (1) See the [Application and Implementation](#) section.
- (2) In applications where high power dissipation, poor package thermal resistance is present, the maximum ambient temperature can be derated. Maximum ambient temperature [T<sub>A(max)</sub>] is dependent on the maximum operating junction temperature [T<sub>J(max)</sub>], the maximum power dissipation of the device in the application [P<sub>D(max)</sub>], and the junction-to-ambient thermal resistance of the part, package in the application (R<sub>θJA</sub>), as given by the following equation: T<sub>A(max)</sub> = T<sub>J(max)</sub> - (R<sub>θJA</sub> × P<sub>D(max)</sub>).

## 7.4 Thermal Information

| THERMAL METRIC <sup>(1)</sup> |  | TPS22965-Q1, TPS22965N-Q1 | TPS22965W-Q1, TPS22965NW-Q1 | UNIT |
|-------------------------------|--|---------------------------|-----------------------------|------|
|                               |  | DSG0008A (WSON)           | DSG0008B (WSON)             |      |
|                               |  | 8 PINS                    | 8 PINS                      |      |
| R <sub>θJA</sub>              | Junction-to-ambient thermal resistance       | 72.3                      | 67.6                        | °C/W |
| R <sub>θJC(top)</sub>         | Junction-to-case (top) thermal resistance    | 96.1                      | 95                          | °C/W |
| R <sub>θJB</sub>              | Junction-to-board thermal resistance         | 42.1                      | 37.4                        | °C/W |
| ψ <sub>JT</sub>               | Junction-to-top characterization parameter   | 3.3                       | 2.9                         | °C/W |
| ψ <sub>JB</sub>               | Junction-to-board characterization parameter | 42.5                      | 37.7                        | °C/W |
| R <sub>θJC(bot)</sub>         | Junction-to-case (bottom) thermal resistance | 13.2                      | 8                           | °C/W |

(1) For more information about traditional and new thermal metrics, see the [Semiconductor and IC Package Thermal Metrics](#) application report.

## 7.5 Electrical Characteristics—V<sub>BIAS</sub> = 5 V

Unless otherwise noted, the specification in the following table applies over the operating ambient temperature:  $-40^{\circ}\text{C} \leq T_A \leq +105^{\circ}\text{C}$  (TPS22965N-Q1, TPS22965-Q1),  $-40^{\circ}\text{C} \leq T_A \leq +125^{\circ}\text{C}$  (TPS22965NW-Q1, TPS22965W-Q1). Typical values are for  $T_A = 25^{\circ}\text{C}$ .

| PARAMETER                          |  | TEST CONDITIONS   | T <sub>A</sub>          | MIN             | TYP  | MAX | UNIT |
|------------------------------------|--|---|-------------------------|-----------------|------|-----|------|
| <b>POWER SUPPLIES AND CURRENTS</b> |  |   |                         |                 |      |     |      |
| I <sub>Q</sub> V <sub>BIAS</sub>   | V <sub>BIAS</sub> quiescent current      | I <sub>OUT</sub> = 0 mA,<br>V <sub>IN</sub> = V <sub>ON</sub> = V <sub>BIAS</sub> = 5 V | -40°C to +105°C         | 50              | 75   |     | μA   |
|                                    |  |   | -40°C to +125°C         | 50              | 75   |     |      |
| I <sub>SD</sub> V <sub>BIAS</sub>  | V <sub>BIAS</sub> shutdown current       | V <sub>ON</sub> = GND, V <sub>OUT</sub> = 0 V   | -40°C to +105°C         |                 |      | 2   | μA   |
|                                    |  |   | -40°C to +125°C         |                 |      | 2   |      |
| I <sub>SD</sub> V <sub>IN</sub>    | V <sub>IN</sub> off-state supply current | V <sub>ON</sub> = GND,<br>V <sub>OUT</sub> = 0 V  | V <sub>IN</sub> = 5 V   | -40°C to +105°C | 0.2  | 8   | μA   |
|                                    |  |   |                         | -40°C to +125°C |      | 36  |      |
|                                    |  |   | V <sub>IN</sub> = 3.3 V | -40°C to +105°C | 0.02 | 3   |      |
|                                    |  |   |                         | -40°C to +125°C |      | 13  |      |
|                                    |  |   | V <sub>IN</sub> = 1.8 V | -40°C to +105°C | 0.01 | 2   |      |
|                                    |  |   |                         | -40°C to +125°C |      | 6   |      |
| V <sub>IN</sub> = 0.8 V            | -40°C to +105°C                          | 0.005   | 1                       |                 |      |     |      |
|                                    | -40°C to +125°C                          |   | 4                       |                 |      |     |      |
| I <sub>ON</sub>                    | ON pin input leakage current             | V <sub>ON</sub> = 5.5 V   | -40°C to +105°C         |                 |      | 0.5 | μA   |
|                                    |  |   | -40°C to +125°C         |                 |      | 0.5 |      |

### 7.5 Electrical Characteristics— $V_{BIAS} = 5\text{ V}$ (continued)

Unless otherwise noted, the specification in the following table applies over the operating ambient temperature:  $-40^{\circ}\text{C} \leq T_A \leq +105^{\circ}\text{C}$  (TPS22965N-Q1, TPS22965-Q1),  $-40^{\circ}\text{C} \leq T_A \leq +125^{\circ}\text{C}$  (TPS22965NW-Q1, TPS22965W-Q1). Typical values are for  $T_A = 25^{\circ}\text{C}$ .

| PARAMETER                         | TEST CONDITIONS                      | $T_A$   | MIN                     | TYP                                  | MAX | UNIT |    |
|-----------------------------------|--------------------------------------|---|-------------------------|--------------------------------------|-----|------|----|
| <b>RESISTANCE CHARACTERISTICS</b> |                                      |   |                         |                                      |     |      |    |
| $R_{ON}$                          | ON-state resistance                  | $I_{OUT} = -200\text{ mA}$ ,<br>$V_{BIAS} = 5\text{ V}$                 | $V_{IN} = 5\text{ V}$   | 25°C                                 | 16  | 23   | mΩ |
|                                   |                                      |   |                         | -40°C to +105°C<br>965N-Q1, 965-Q1   |     | 25   |    |
|                                   |                                      |   |                         | -40°C to +105°C<br>965NW-Q1, 965W-Q1 |     | 26   |    |
|                                   |                                      |   |                         | -40°C to +125°C                      |     | 28   |    |
|                                   |                                      |   | $V_{IN} = 3.3\text{ V}$ | 25°C                                 | 16  | 23   | mΩ |
|                                   |                                      |   |                         | -40°C to +105°C<br>965N-Q1, 965-Q1   |     | 25   |    |
|                                   |                                      |   |                         | -40°C to +105°C<br>965NW-Q1, 965W-Q1 |     | 26   |    |
|                                   |                                      |   |                         | -40°C to +125°C                      |     | 27   |    |
|                                   |                                      |   | $V_{IN} = 1.8\text{ V}$ | 25°C                                 | 16  | 23   | mΩ |
|                                   |                                      |   |                         | -40°C to +105°C<br>965N-Q1, 965-Q1   |     | 25   |    |
|                                   |                                      |   |                         | -40°C to +105°C<br>965NW-Q1, 965W-Q1 |     | 26   |    |
|                                   |                                      |   |                         | -40°C to +125°C                      |     | 27   |    |
|                                   |                                      |   | $V_{IN} = 1.5\text{ V}$ | 25°C                                 | 16  | 23   | mΩ |
|                                   |                                      |   |                         | -40°C to +105°C<br>965N-Q1, 965-Q1   |     | 25   |    |
|                                   |                                      |   |                         | -40°C to +105°C<br>965NW-Q1, 965W-Q1 |     | 26   |    |
|                                   |                                      |   |                         | -40°C to +125°C                      |     | 27   |    |
|                                   |                                      |   | $V_{IN} = 1.2\text{ V}$ | 25°C                                 | 16  | 23   | mΩ |
|                                   |                                      |   |                         | -40°C to +105°C<br>965N-Q1, 965-Q1   |     | 25   |    |
|                                   |                                      |   |                         | -40°C to +105°C<br>965NW-Q1, 965W-Q1 |     | 26   |    |
|                                   |                                      |   |                         | -40°C to +125°C                      |     | 27   |    |
| $V_{IN} = 0.8\text{ V}$           | 25°C                                 | 16  | 23                      | mΩ                                   |     |      |    |
|                                   | -40°C to +105°C<br>965N-Q1, 965-Q1   |   | 25                      |                                      |     |      |    |
|                                   | -40°C to +105°C<br>965NW-Q1, 965W-Q1 |   | 26                      |                                      |     |      |    |
|                                   | -40°C to +125°C                      |   | 27                      |                                      |     |      |    |
| $R_{PD}^{(1)}$                    | Output pulldown resistance           | $V_{IN} = 5\text{ V}$ , $V_{ON} = 0\text{ V}$ , $I_{OUT} = 1\text{ mA}$ | -40°C to +105°C         | 225                                  | 300 | Ω    |    |
|                                   |                                      |   | -40°C to +125°C         | 225                                  | 300 |      |    |

(1) TPS22965-Q1 and TPS22965W-Q1 only.

## 7.6 Electrical Characteristics— $V_{BIAS} = 2.5\text{ V}$

Unless otherwise noted, the specification in the following table applies over the operating ambient temperature:  $-40^{\circ}\text{C} \leq T_A \leq +105^{\circ}\text{C}$  (TPS22965N-Q1, TPS22965-Q1),  $-40^{\circ}\text{C} \leq T_A \leq +125^{\circ}\text{C}$  (TPS22965NW-Q1, TPS22965W-Q1). Typical values are for  $T_A = 25^{\circ}\text{C}$ .

| PARAMETER                          |                                   | TEST CONDITIONS  | $T_A$   | MIN   | TYP   | MAX | UNIT          |  |
|------------------------------------|-----------------------------------|--|---|---|-------|-----|---------------|--|
| <b>POWER SUPPLIES AND CURRENTS</b> |                                   |  |   |   |       |     |               |  |
| $I_Q$ $V_{BIAS}$                   | $V_{BIAS}$ quiescent current      | $I_{OUT} = 0\text{ mA}$ ,<br>$V_{IN} = V_{ON} = V_{BIAS} = 2.5\text{ V}$ | $-40^{\circ}\text{C}$ to $+105^{\circ}\text{C}$ | 20  | 30    |     | $\mu\text{A}$ |  |
|                                    |                                   |  | $-40^{\circ}\text{C}$ to $125^{\circ}\text{C}$  | 20  | 30    |     |               |  |
| $I_{SD}$ $V_{BIAS}$                | $V_{BIAS}$ shutdown current       | $V_{ON} = \text{GND}$ , $V_{OUT} = 0\text{ V}$                           | $-40^{\circ}\text{C}$ to $+105^{\circ}\text{C}$ |   |       | 2   | $\mu\text{A}$ |  |
|                                    |                                   |  | $-40^{\circ}\text{C}$ to $125^{\circ}\text{C}$  |   |       | 2   |               |  |
| $I_{SD}$ $V_{IN}$                  | $V_{IN}$ off-state supply current | $V_{ON} = \text{GND}$ ,<br>$V_{OUT} = 0\text{ V}$                        | $V_{IN} = 2.5\text{ V}$                         | $-40^{\circ}\text{C}$ to $+105^{\circ}\text{C}$ | 0.01  | 3   | $\mu\text{A}$ |  |
|                                    |                                   |  |   | $-40^{\circ}\text{C}$ to $125^{\circ}\text{C}$  |       | 13  |               |  |
|                                    |                                   |  | $V_{IN} = 1.8\text{ V}$                         | $-40^{\circ}\text{C}$ to $+105^{\circ}\text{C}$ | 0.01  | 2   |               |  |
|                                    |                                   |  |   | $-40^{\circ}\text{C}$ to $125^{\circ}\text{C}$  |       | 6   |               |  |
|                                    |                                   |  | $V_{IN} = 1.2\text{ V}$                         | $-40^{\circ}\text{C}$ to $+105^{\circ}\text{C}$ | 0.005 | 2   |               |  |
|                                    |                                   |  |   | $-40^{\circ}\text{C}$ to $125^{\circ}\text{C}$  |       | 6   |               |  |
|                                    |                                   |  | $V_{IN} = 0.8\text{ V}$                         | $-40^{\circ}\text{C}$ to $+105^{\circ}\text{C}$ | 0.003 | 1   |               |  |
|                                    |                                   |  |   | $-40^{\circ}\text{C}$ to $125^{\circ}\text{C}$  |       | 4   |               |  |
| $I_{ON}$                           | ON pin input leakage current      | $V_{ON} = 5.5\text{ V}$  | $-40^{\circ}\text{C}$ to $+105^{\circ}\text{C}$ |   |       | 0.5 | $\mu\text{A}$ |  |
|                                    |                                   |  | $-40^{\circ}\text{C}$ to $+125^{\circ}\text{C}$ |   |       | 0.5 |               |  |
| <b>RESISTANCE CHARACTERISTICS</b>  |                                   |  |   |   |       |     |               |  |

### 7.6 Electrical Characteristics— $V_{BIAS} = 2.5\text{ V}$ (continued)

Unless otherwise noted, the specification in the following table applies over the operating ambient temperature:  $-40^{\circ}\text{C} \leq T_A \leq +105^{\circ}\text{C}$  (TPS22965N-Q1, TPS22965-Q1),  $-40^{\circ}\text{C} \leq T_A \leq +125^{\circ}\text{C}$  (TPS22965NW-Q1, TPS22965W-Q1). Typical values are for  $T_A = 25^{\circ}\text{C}$ .

| PARAMETER      |                            | TEST CONDITIONS  |  | $T_A$                                | MIN | TYP | MAX | UNIT |
|----------------|----------------------------|--|--|--------------------------------------|-----|-----|-----|------|
| $R_{ON}$       | ON-state resistance        | $I_{OUT} = -200\text{ mA}$ ,<br>$V_{BIAS} = 2.5\text{ V}$                            | $V_{IN} = 2.5\text{ V}$  | 25°C                                 |     | 20  | 26  | mΩ   |
|                |                            |  |  | -40°C to +105°C<br>965N-Q1, 965-Q1   |     |     | 28  |      |
|                |                            |  |  | -40°C to +105°C<br>965NW-Q1, 965W-Q1 |     |     | 32  |      |
|                |                            |  |  | -40°C to +125°C                      |     |     | 34  |      |
|                |                            |  | $V_{IN} = 1.8\text{ V}$  | 25°C                                 |     | 19  | 26  | mΩ   |
|                |                            |  |  | -40°C to +105°C<br>965N-Q1, 965-Q1   |     |     | 28  |      |
|                |                            |  |  | -40°C to +105°C<br>965NW-Q1, 965W-Q1 |     |     | 30  |      |
|                |                            |  |  | -40°C to +125°C                      |     |     | 32  |      |
|                |                            |  | $V_{IN} = 1.5\text{ V}$  | 25°C                                 |     | 18  | 25  | mΩ   |
|                |                            |  |  | -40°C to +105°C<br>965N-Q1, 965-Q1   |     |     | 27  |      |
|                |                            |  |  | -40°C to +105°C<br>965NW-Q1/965W-Q1  |     |     | 29  |      |
|                |                            |  |  | -40°C to +125°C                      |     |     | 31  |      |
|                |                            |  | $V_{IN} = 1.2\text{ V}$  | 25°C                                 |     | 18  | 25  | mΩ   |
|                |                            |  |  | -40°C to +105°C<br>965N-Q1, 965-Q1   |     |     | 27  |      |
|                |                            |  |  | -40°C to +105°C<br>965NW-Q1, 965W-Q1 |     |     | 28  |      |
|                |                            |  |  | -40°C to +125°C                      |     |     | 30  |      |
|                |                            |  | $V_{IN} = 0.8\text{ V}$  | 25°C                                 |     | 17  | 25  | mΩ   |
|                |                            |  |  | -40°C to +105°C<br>965N-Q1, 965-Q1   |     |     | 27  |      |
|                |                            |  |  | -40°C to +105°C<br>965NW-Q1, 965W-Q1 |     |     | 28  |      |
|                |                            |  |  | -40°C to +125°C                      |     |     | 30  |      |
| $R_{PD}^{(1)}$ | Output pulldown resistance | $V_{BIAS} = V_{IN} = 2.5\text{ V}$ , $V_{ON} = 0\text{ V}$ , $I_{OUT} = 1\text{ mA}$ | -40°C to +105°C  |                                      | 275 | 325 | Ω   |      |
|                |                            |  | -40°C to +125°C  |                                      |     | 330 |     |      |
|                |                            |  | $V_{BIAS} = V_{IN} = 2\text{ V}$ , $V_{ON} = 0\text{ V}$ , $I_{OUT} = 1\text{ mA}$ | -40°C to +125°C                      |     | 310 | 470 | Ω    |

(1) TPS22965-Q1 and TPS22965W-Q1 only.



## 7.7 Switching Characteristics

Over operating free-air temperature range (unless otherwise noted). These switching characteristics are only valid for the power-up sequence where VIN and VBIAS are already in steady state condition before the ON pin is asserted high.

| PARAMETER  |                            | TEST CONDITIONS  | MIN | TYP  | MAX | UNIT |
|--|----------------------------|--|-----|------|-----|------|
| <b>V<sub>IN</sub> = V<sub>ON</sub> = V<sub>BIAS</sub> = 5 V, T<sub>A</sub> = 25°C (unless otherwise noted)</b>               |                            |  |     |      |     |      |
| t <sub>ON</sub>  | Turn-on time               | R <sub>L</sub> = 10 Ω, C <sub>L</sub> = 0.1 μF, C <sub>T</sub> = 1000 pF, C <sub>IN</sub> = 1 μF |     | 1600 |     | μs   |
| t <sub>OFF</sub>   | Turn-off time              | R <sub>L</sub> = 10 Ω, C <sub>L</sub> = 0.1 μF, C <sub>T</sub> = 1000 pF, C <sub>IN</sub> = 1 μF |     | 9    |     | μs   |
| t <sub>R</sub>   | V <sub>OUT</sub> rise time | R <sub>L</sub> = 10 Ω, C <sub>L</sub> = 0.1 μF, C <sub>T</sub> = 1000 pF, C <sub>IN</sub> = 1 μF |     | 1985 |     | μs   |
| t <sub>F</sub>   | V <sub>OUT</sub> fall time | R <sub>L</sub> = 10 Ω, C <sub>L</sub> = 0.1 μF, C <sub>T</sub> = 1000 pF, C <sub>IN</sub> = 1 μF |     | 3    |     | μs   |
| t <sub>D</sub>   | ON delay time              | R <sub>L</sub> = 10 Ω, C <sub>L</sub> = 0.1 μF, C <sub>T</sub> = 1000 pF, C <sub>IN</sub> = 1 μF |     | 660  |     | μs   |
| <b>V<sub>IN</sub> = 0.8 V, V<sub>ON</sub> = V<sub>BIAS</sub> = 5 V, T<sub>A</sub> = 25°C (unless otherwise noted)</b>        |                            |  |     |      |     |      |
| t <sub>ON</sub>  | Turn-on time               | R <sub>L</sub> = 10 Ω, C <sub>L</sub> = 0.1 μF, C <sub>T</sub> = 1000 pF, C <sub>IN</sub> = 1 μF |     | 730  |     | μs   |
| t <sub>OFF</sub>   | Turn-off time              | R <sub>L</sub> = 10 Ω, C <sub>L</sub> = 0.1 μF, C <sub>T</sub> = 1000 pF, C <sub>IN</sub> = 1 μF |     | 100  |     | μs   |
| t <sub>R</sub>   | V <sub>OUT</sub> rise time | R <sub>L</sub> = 10 Ω, C <sub>L</sub> = 0.1 μF, C <sub>T</sub> = 1000 pF, C <sub>IN</sub> = 1 μF |     | 380  |     | μs   |
| t <sub>F</sub>   | V <sub>OUT</sub> fall time | R <sub>L</sub> = 10 Ω, C <sub>L</sub> = 0.1 μF, C <sub>T</sub> = 1000 pF, C <sub>IN</sub> = 1 μF |     | 8    |     | μs   |
| t <sub>D</sub>   | ON delay time              | R <sub>L</sub> = 10 Ω, C <sub>L</sub> = 0.1 μF, C <sub>T</sub> = 1000 pF, C <sub>IN</sub> = 1 μF |     | 560  |     | μs   |
| <b>V<sub>IN</sub> = 2.5 V, V<sub>ON</sub> = 5 V, V<sub>BIAS</sub> = 2.5 V, T<sub>A</sub> = 25°C (unless otherwise noted)</b> |                            |  |     |      |     |      |
| t <sub>ON</sub>  | Turn-on time               | R <sub>L</sub> = 10 Ω, C <sub>L</sub> = 0.1 μF, C <sub>T</sub> = 1000 pF, C <sub>IN</sub> = 1 μF |     | 2435 |     | μs   |
| t <sub>OFF</sub>   | Turn-off time              | R <sub>L</sub> = 10 Ω, C <sub>L</sub> = 0.1 μF, C <sub>T</sub> = 1000 pF, C <sub>IN</sub> = 1 μF |     | 9    |     | μs   |
| t <sub>R</sub>   | V <sub>OUT</sub> rise time | R <sub>L</sub> = 10 Ω, C <sub>L</sub> = 0.1 μF, C <sub>T</sub> = 1000 pF, C <sub>IN</sub> = 1 μF |     | 2515 |     | μs   |
| t <sub>F</sub>   | V <sub>OUT</sub> fall time | R <sub>L</sub> = 10 Ω, C <sub>L</sub> = 0.1 μF, C <sub>T</sub> = 1000 pF, C <sub>IN</sub> = 1 μF |     | 4    |     | μs   |
| t <sub>D</sub>   | ON delay time              | R <sub>L</sub> = 10 Ω, C <sub>L</sub> = 0.1 μF, C <sub>T</sub> = 1000 pF, C <sub>IN</sub> = 1 μF |     | 1230 |     | μs   |
| <b>V<sub>IN</sub> = 0.8 V, V<sub>ON</sub> = 5 V, V<sub>BIAS</sub> = 2.5 V, T<sub>A</sub> = 25°C (unless otherwise noted)</b> |                            |  |     |      |     |      |
| t <sub>ON</sub>  | Turn-on time               | R <sub>L</sub> = 10 Ω, C <sub>L</sub> = 0.1 μF, C <sub>T</sub> = 1000 pF, C <sub>IN</sub> = 1 μF |     | 1565 |     | μs   |
| t <sub>OFF</sub>   | Turn-off time              | R <sub>L</sub> = 10 Ω, C <sub>L</sub> = 0.1 μF, C <sub>T</sub> = 1000 pF, C <sub>IN</sub> = 1 μF |     | 70   |     | μs   |
| t <sub>R</sub>   | V <sub>OUT</sub> rise time | R <sub>L</sub> = 10 Ω, C <sub>L</sub> = 0.1 μF, C <sub>T</sub> = 1000 pF, C <sub>IN</sub> = 1 μF |     | 930  |     | μs   |
| t <sub>F</sub>   | V <sub>OUT</sub> fall time | R <sub>L</sub> = 10 Ω, C <sub>L</sub> = 0.1 μF, C <sub>T</sub> = 1000 pF, C <sub>IN</sub> = 1 μF |     | 8    |     | μs   |
| t <sub>D</sub>   | ON delay time              | R <sub>L</sub> = 10 Ω, C <sub>L</sub> = 0.1 μF, C <sub>T</sub> = 1000 pF, C <sub>IN</sub> = 1 μF |     | 1110 |     | μs   |

## 7.8 Typical Characteristics

### 7.8.1 Typical DC Characteristics

T<sub>A</sub> = 125°C data is only applicable to TPS22965NW-Q1 and TPS22965W-Q1.

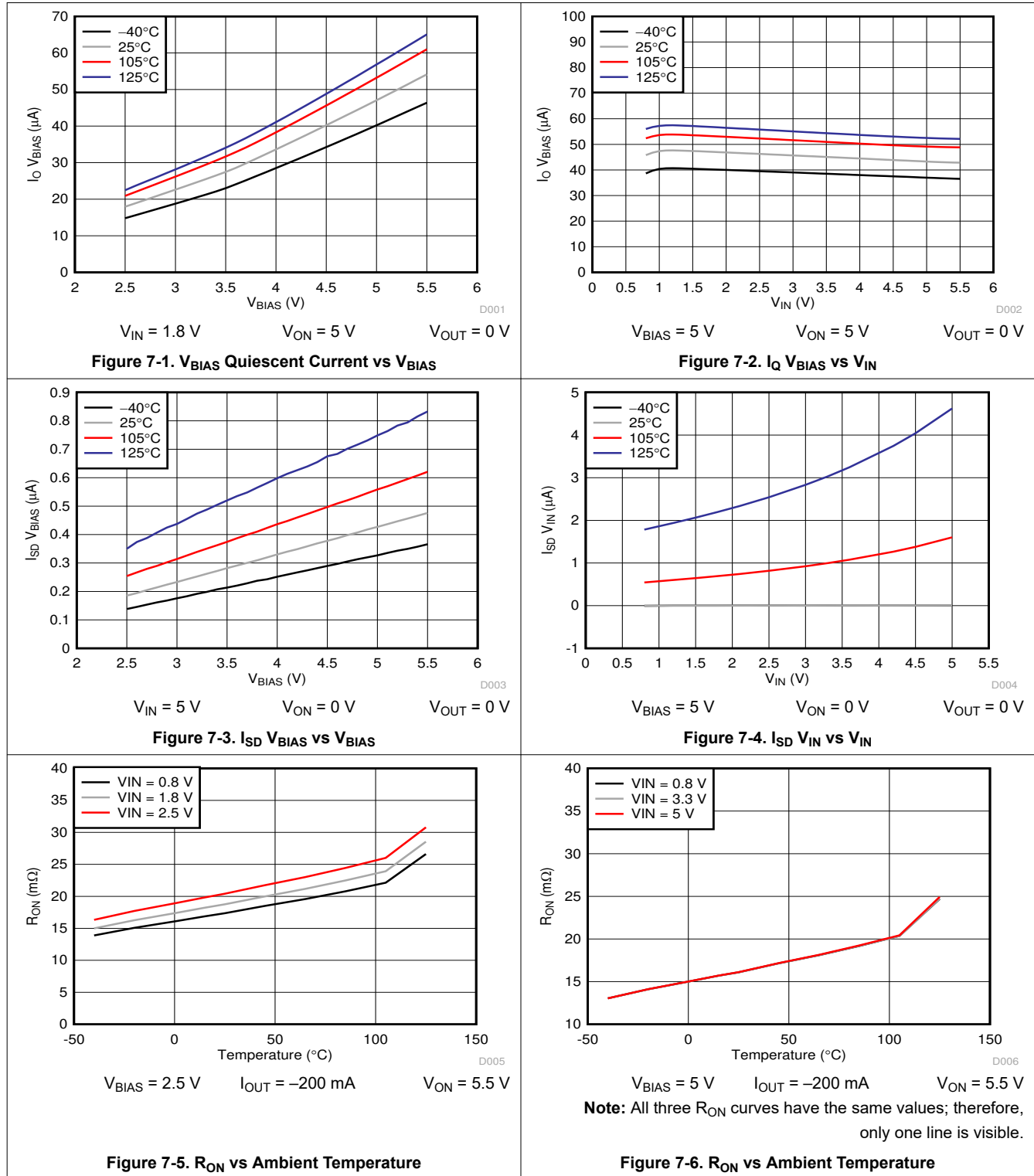

### 7.8.1 Typical DC Characteristics (continued)

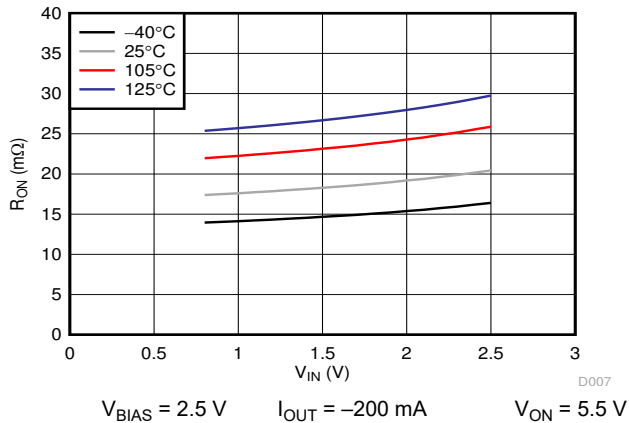

Figure 7-7.  $R_{ON}$  vs  $V_{IN}$

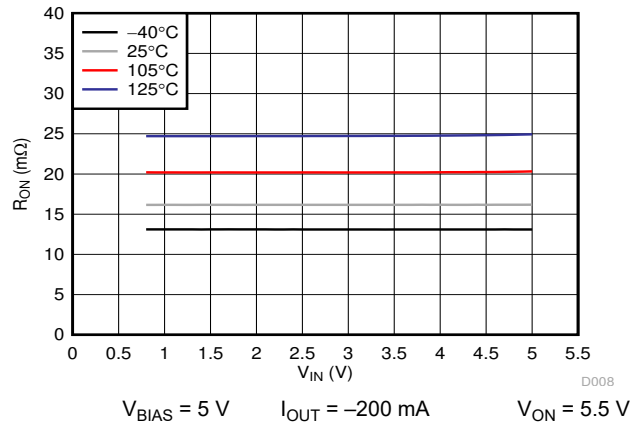

Figure 7-8.  $R_{ON}$  vs  $V_{IN}$

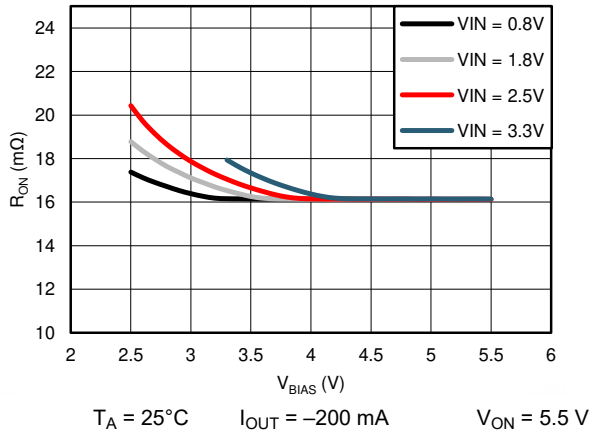

Figure 7-9.  $R_{ON}$  vs  $V_{BIAS}$

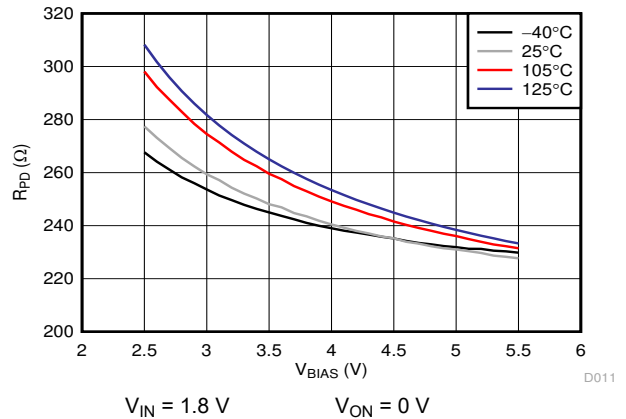

Figure 7-10.  $R_{PD}$  vs  $V_{BIAS}$

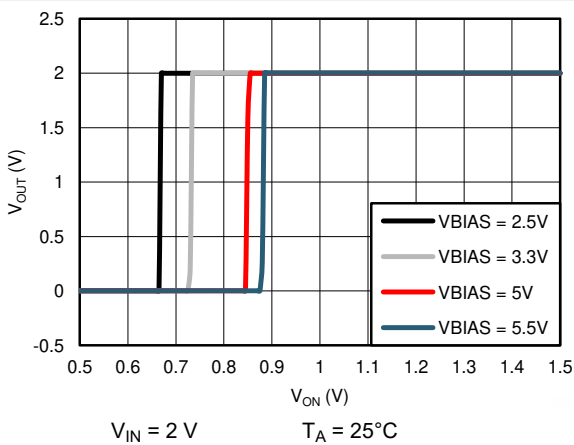

Figure 7-11.  $V_{OUT}$  vs  $V_{ON}$

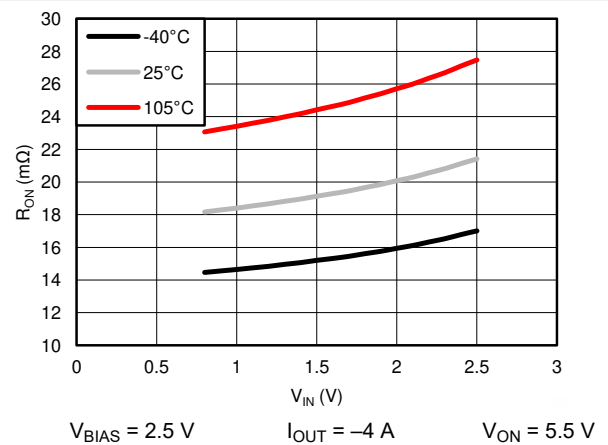
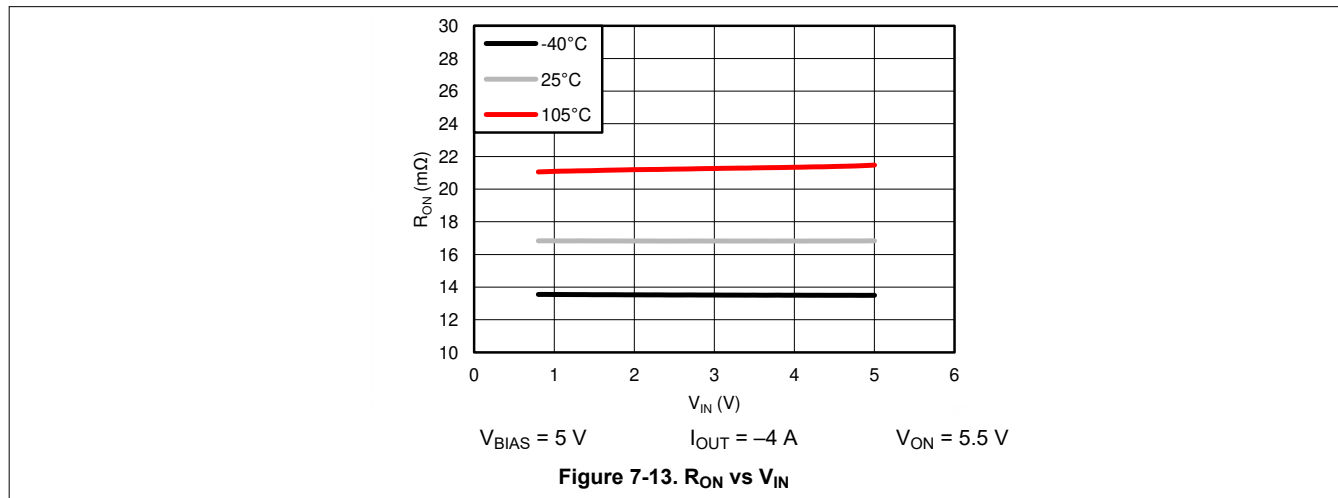

Figure 7-12.  $R_{ON}$  vs  $V_{IN}$

### 7.8.1 Typical DC Characteristics (continued)



### 7.8.2 Typical Switching Characteristics

$T_A = 25^\circ\text{C}$ ,  $C_T = 1000\text{ pF}$ ,  $C_{IN} = 1\text{ }\mu\text{F}$ ,  $C_L = 0.1\text{ }\mu\text{F}$ ,  $R_L = 10\text{ }\Omega$  (unless otherwise specified).  $T_A = 125^\circ\text{C}$  data is only applicable to TPS22965NW-Q1 and TPS22965W-Q1.

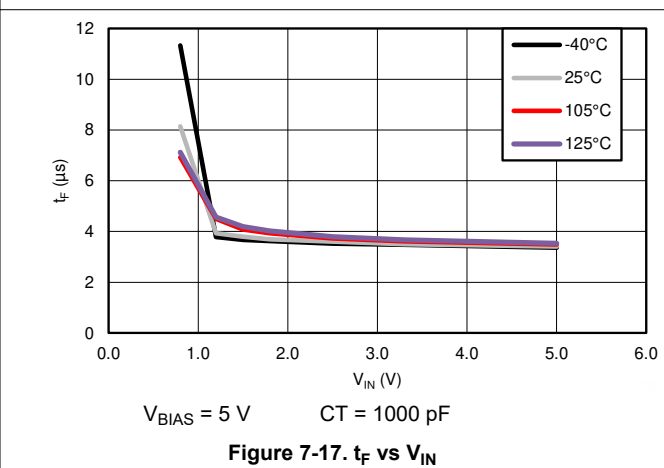
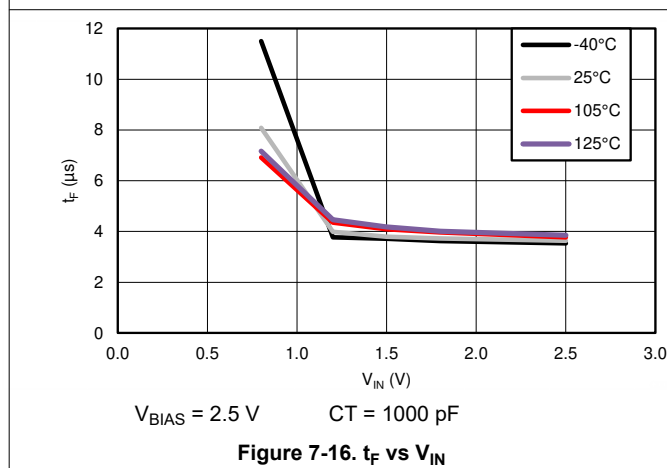
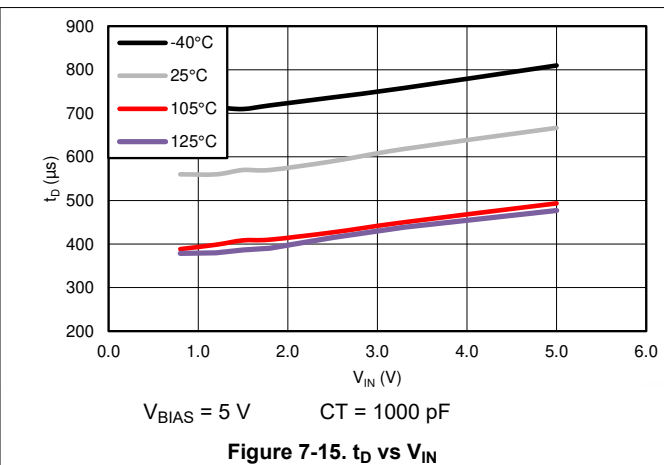
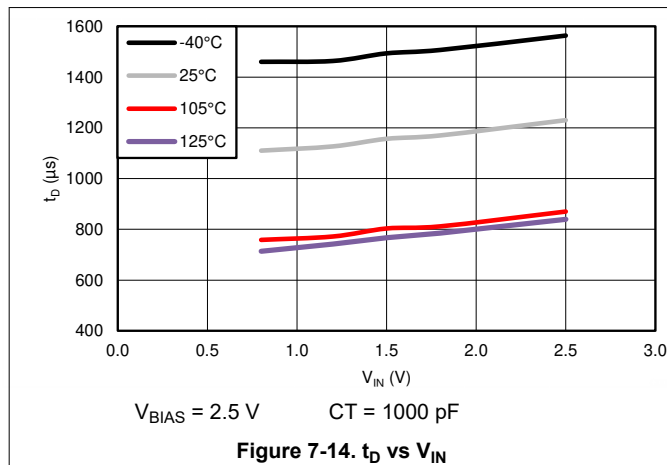

### 7.8.2 Typical Switching Characteristics (continued)

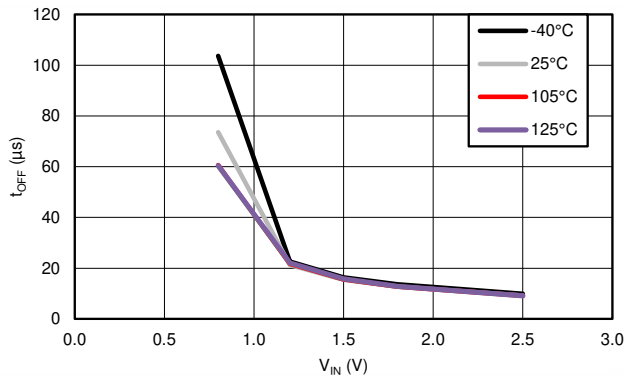

$V_{BIAS} = 2.5\text{ V}$       $CT = 1000\text{ pF}$

**Note:** The 105°C and 125°C curves have similar values; therefore, only one line is visible.

**Figure 7-18.  $t_{OFF}$  vs  $V_{IN}$**

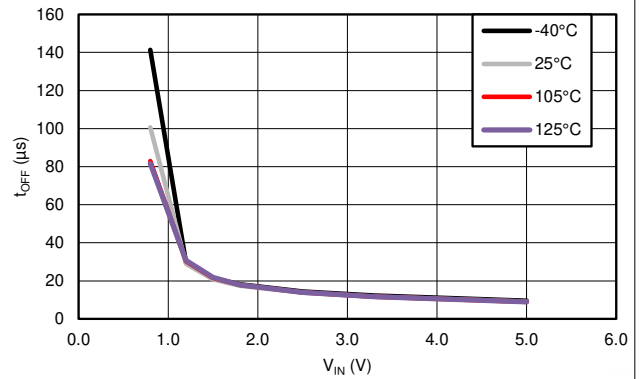

$V_{BIAS} = 5\text{ V}$       $CT = 1000\text{ pF}$

**Note:** The 105°C and 125°C curves have similar values; therefore, only one line is visible.

**Figure 7-19.  $t_{OFF}$  vs  $V_{IN}$**

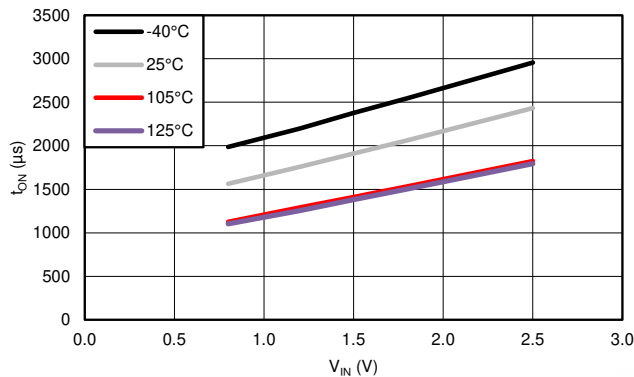

$V_{BIAS} = 2.5\text{ V}$       $CT = 1000\text{ pF}$

**Figure 7-20.  $t_{ON}$  vs  $V_{IN}$**

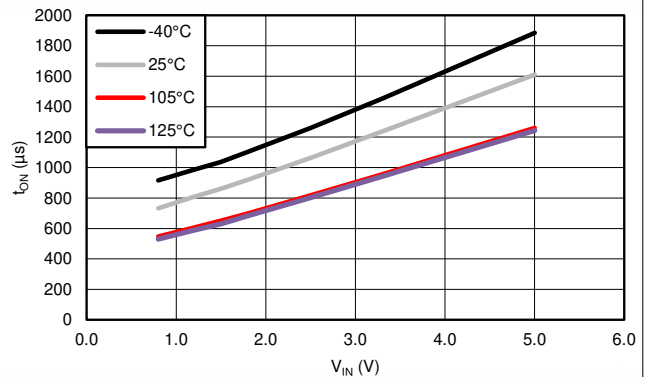

$V_{BIAS} = 5\text{ V}$       $CT = 1000\text{ pF}$

**Figure 7-21.  $t_{ON}$  vs  $V_{IN}$**

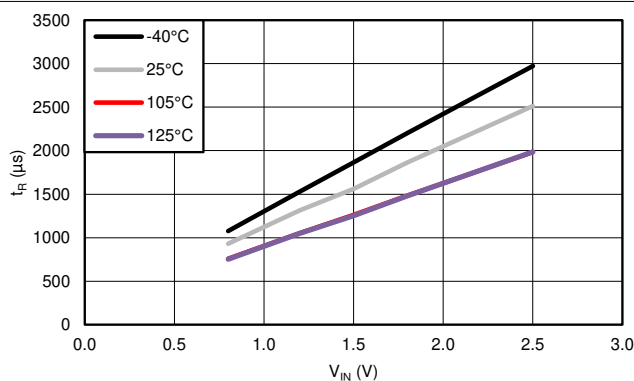

$V_{BIAS} = 2.5\text{ V}$       $CT = 1000\text{ pF}$

**Note:** The 105°C and 125°C curves have similar values; therefore, only one line is visible.

**Figure 7-22.  $t_R$  vs  $V_{IN}$**

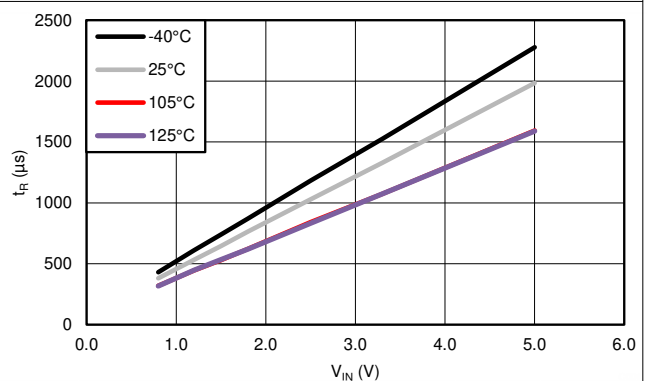

$V_{BIAS} = 5\text{ V}$       $CT = 1000\text{ pF}$

**Note:** The 105°C and 125°C curves have similar values; therefore, only one line is visible.

**Figure 7-23.  $t_R$  vs  $V_{IN}$**

### 7.8.2 Typical Switching Characteristics (continued)

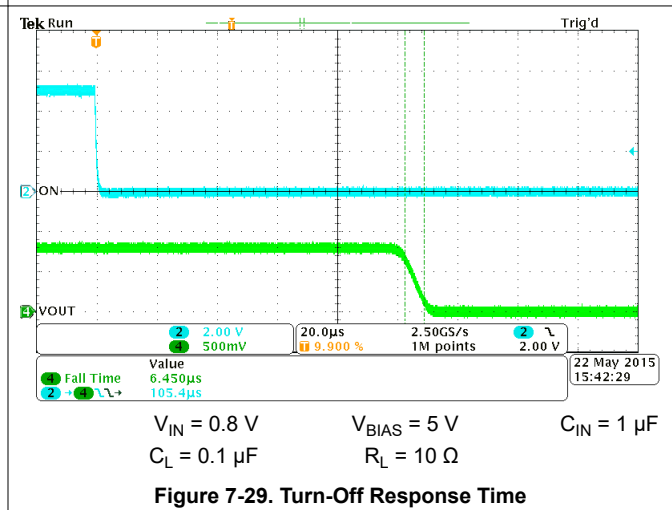
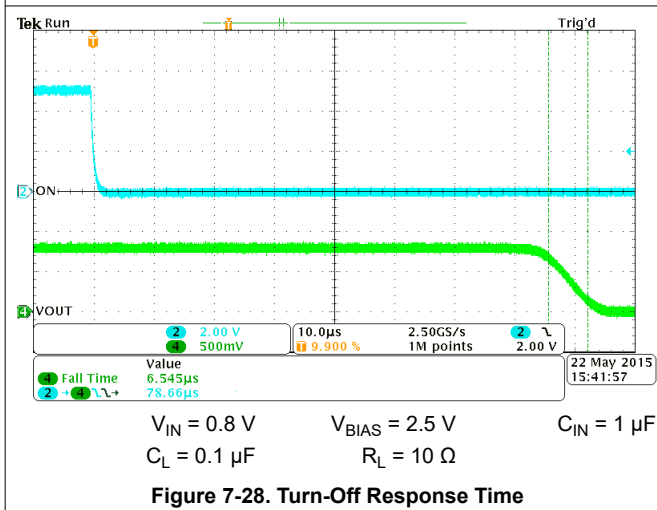
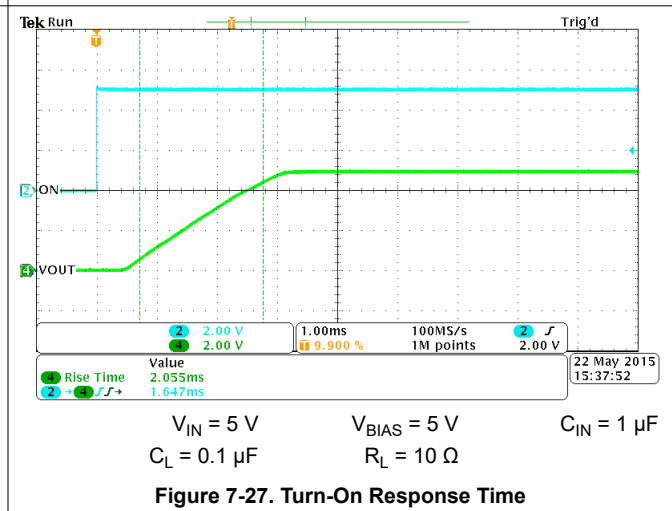
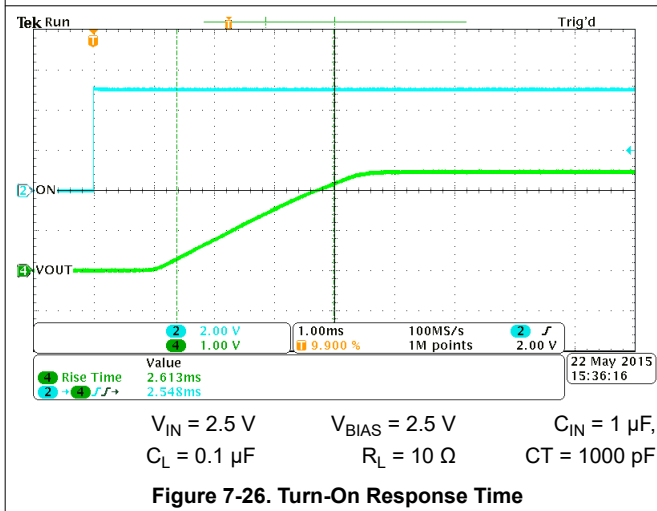
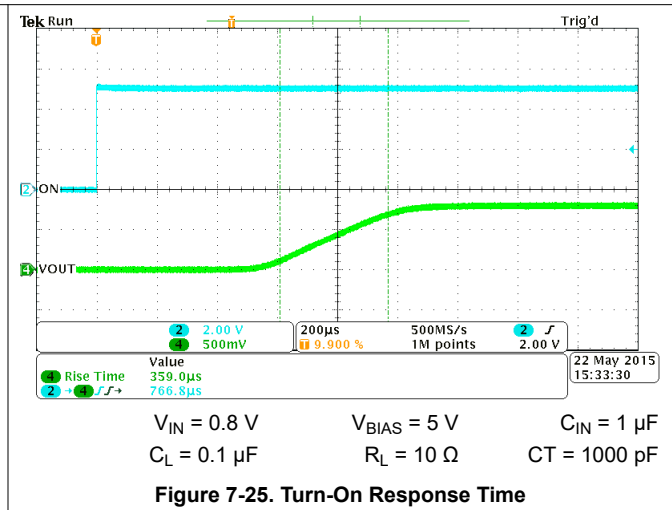
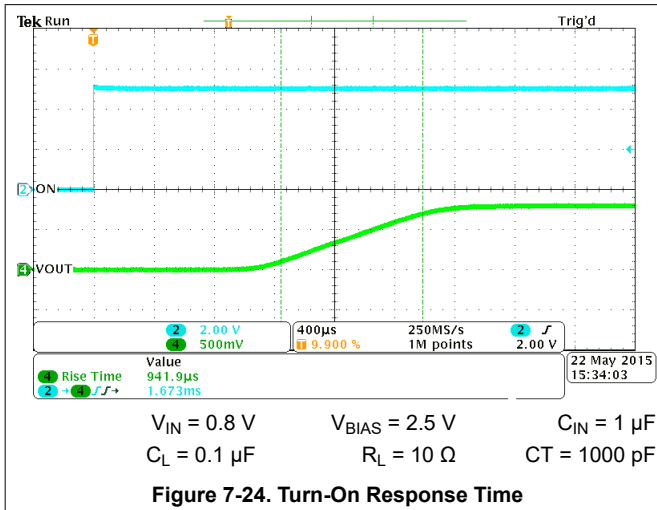

### 7.8.2 Typical Switching Characteristics (continued)

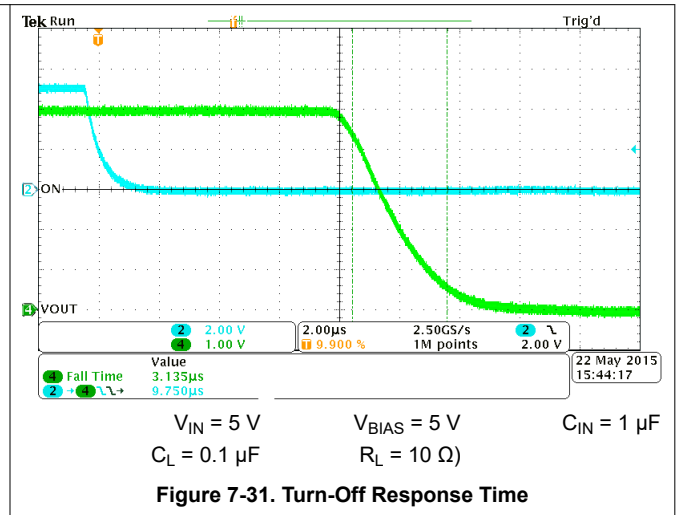
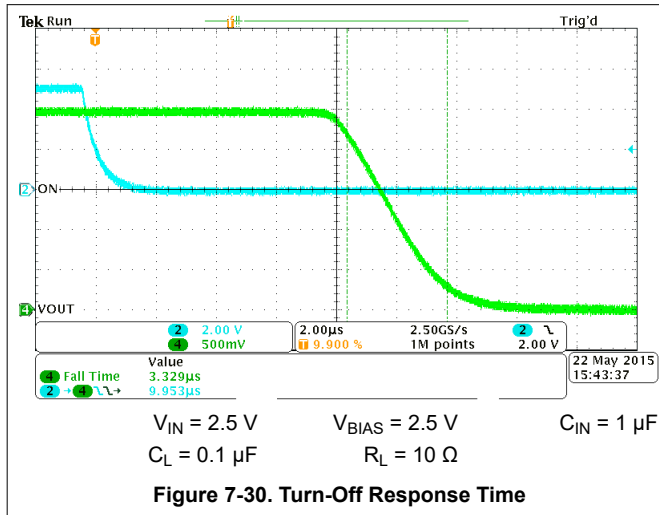

## 8 Parameter Measurement Information

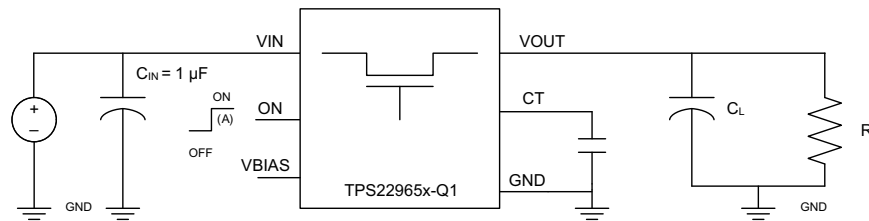

A. Rise and fall times of the control signal are 100 ns.

**Figure 8-1. Test Circuit**

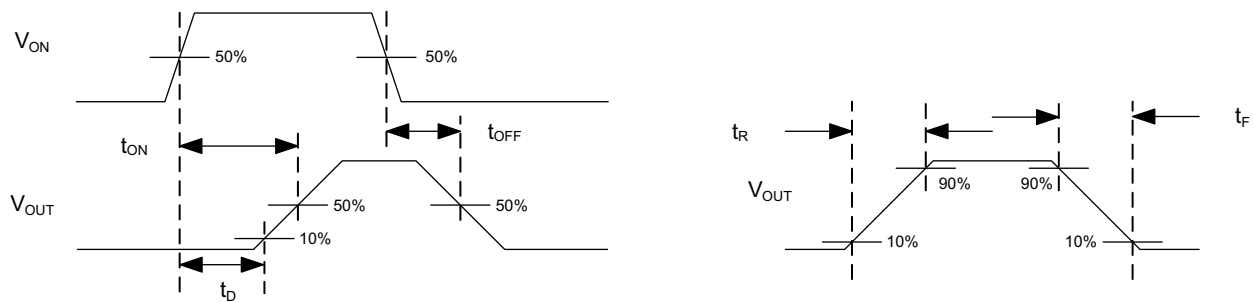

**Figure 8-2.  $t_{ON}$  and  $t_{OFF}$  Waveforms**

## 9 Detailed Description

### 9.1 Overview

The TPS22965x-Q1 is a single-channel, 4-A load switch in an 8-pin WSON package. To reduce the voltage drop in high current rails, the device implements an ultra-low resistance N-channel MOSFET. The device has a programmable slew rate for applications that require specific rise time.

The device has very low leakage current during OFF state. This low leakage prevents downstream circuits from pulling high standby current from the supply. Integrated control logic, driver, power supply, and output discharge FET eliminates the need for any external components, which reduces solution size and BOM count.

### 9.2 Functional Block Diagram

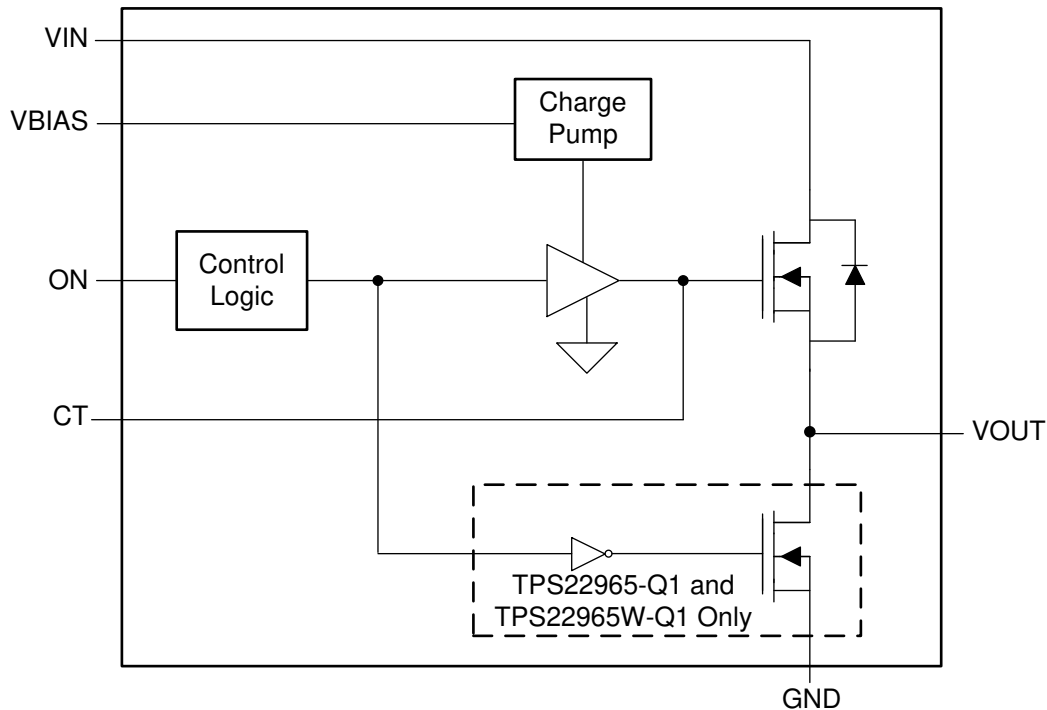



## 9.3 Feature Description

### 9.3.1 Adjustable Rise Time

A capacitor to GND on the CT pin sets the slew rate. The voltage on the CT pin can be as high as 12 V. Therefore, the minimum voltage rating for the CT cap must be 25 V for optimal performance. The below equations shows an approximate formula for the relationship between CT and slew rate when  $V_{BIAS}$  is set to 5 V. This equation accounts for 10% to 90% measurement on  $V_{OUT}$  and does *not* apply for CT = 0 pF. Use the below equation to determine rise times for when CT = 0 pF.

$$SR = 0.38 \times CT + 34 \quad (1)$$

where

- SR = slew rate (in  $\mu\text{s}/\text{V}$ ).
- CT = the capacitance value on the CT pin (in pF).
- The units for the constant 34 are  $\mu\text{s}/\text{V}$ . The units for the constant 0.38 are  $\mu\text{s}/(\text{V} \times \text{pF})$ .

Rise time can be calculated by multiplying the input voltage by the slew rate. [Table 9-1](#) contains rise time values measured on a typical device. The rise times listed in [Table 9-1](#) are only valid for the power-up sequence where  $V_{IN}$  and  $V_{BIAS}$  are already in steady state condition before the ON pin is asserted high.

**Table 9-1. Rise Time vs CT Capacitor**

| CT (pF) | RISE TIME ( $\mu\text{s}$ ) 10% - 90%, $C_L = 0.1 \mu\text{F}$ , $C_{IN} = 1 \mu\text{F}$ , $R_L = 10 \Omega$ , $V_{BIAS} = 5 \text{V}$ <sup>(1)</sup> |             |             |             |             |              |             |
|---------|--|-------------|-------------|-------------|-------------|--------------|-------------|
|         | VIN = 5 V  | VIN = 3.3 V | VIN = 1.8 V | VIN = 1.5 V | VIN = 1.2 V | VIN = 1.05 V | VIN = 0.8 V |
| 0       | 180  | 136         | 94          | 84          | 74          | 70           | 60          |
| 220     | 547  | 378         | 232         | 202         | 173         | 157          | 129         |
| 470     | 962  | 654         | 386         | 333         | 282         | 252          | 206         |
| 1000    | 1983   | 1330        | 765         | 647         | 533         | 476          | 382         |
| 2200    | 4013   | 2693        | 1537        | 1310        | 1077        | 959          | 766         |
| 4700    | 8207   | 5490        | 3137        | 2693        | 2200        | 1970         | 1590        |
| 10000   | 17700  | 11767       | 6697        | 5683        | 4657        | 4151         | 3350        |

(1) Typical Values at 25°C with a 25-V X7R 10% Ceramic Capacitor on CT

### 9.3.2 Quick Output Discharge (TPS22965-Q1 and TPS22965W-Q1 Only)

The TPS22965-Q1 and TPS22965W-Q1 include a Quick Output Discharge (QOD) feature. When the switch is disabled, a discharge resistor is connected between VOUT and GND. This resistor has a typical value of 225  $\Omega$  and prevents the output from floating while the switch is disabled.

### 9.3.3 Low Power Consumption During OFF State

The  $I_{SD}$   $V_{IN}$  supply current is 0.01- $\mu\text{A}$  typical at 1.8 V  $V_{IN}$ . Typically, the downstream loads must have a significantly higher off-state leakage current. The load switch allows system standby power consumption to be reduced.

## 9.4 Device Functional Modes

The below table lists the VOUT pin state as determined by the ON pin.

**Table 9-2. Functional Table**

| ON | TPS22965N-Q1 AND<br>TPS22965NW-Q1 | TPS22965-Q1 AND<br>TPS22965W-Q1 |
|----|-----------------------------------|---------------------------------|
| L  | Open                              | GND                             |
| H  | VIN                               | VIN                             |

## 10 Application and Implementation

### Note

Information in the following applications sections is not part of the TI component specification, and TI does not warrant its accuracy or completeness. TI's customers are responsible for determining suitability of components for their purposes, as well as validating and testing their design implementation to confirm system functionality.

### 10.1 Application Information

This section highlights some of the design considerations when implementing this device in various applications. A PSPICE model for this device is also available in the product page of this device on [www.ti.com](http://www.ti.com) for further aid.

#### 10.1.1 VIN to VOUT Voltage Drop

The VIN to VOUT voltage drop in the device is determined by the  $R_{ON}$  of the device and the load current. The  $R_{ON}$  of the device depends upon the  $V_{IN}$  and  $V_{BIAS}$  conditions of the device. Refer to the  $R_{ON}$  specification of the device in the *Electrical Characteristics— $V_{BIAS} = 2\text{ V to } 2.5\text{ V}$*  table of this data sheet. After the  $R_{ON}$  of the device is determined based upon the  $V_{IN}$  and  $V_{BIAS}$  conditions, use the following equation to calculate the VIN to VOUT voltage drop.

$$\Delta V = I_{LOAD} \times R_{ON} \quad (2)$$

where

- $\Delta V$  = voltage drop from VIN to VOUT.
- $I_{LOAD}$  = load current.
- $R_{ON}$  = On-resistance of the device for a specific  $V_{IN}$  and  $V_{BIAS}$  combination.

An appropriate  $I_{LOAD}$  must be chosen such that the  $I_{MAX}$  specification of the device is not violated.

#### 10.1.2 On and Off Control

The ON pin controls the state of the switch. ON is active high and has a low threshold, making it capable of interfacing with low-voltage signals. The ON pin is compatible with standard GPIO logic thresholds. The ON pin can be used with any microcontroller with 1.2 V or higher GPIO voltage. This pin cannot be left floating and must be driven either high or low for proper functionality.

#### 10.1.3 Input Capacitor (Optional)

To limit the voltage drop on the input supply caused by transient inrush currents when the switch turns on into a discharged load capacitor or short circuit, a capacitor must be placed between VIN and GND. A 1- $\mu\text{F}$  ceramic capacitor,  $C_{IN}$ , placed close to the pins, is usually sufficient. Higher values of  $C_{IN}$  can be used to further reduce the voltage drop during high current applications. When switching heavy loads, TI recommends to have an input capacitor about 10 times higher than the output capacitor to avoid excessive voltage drop.

#### 10.1.4 Output Capacitor (Optional)

Due to the integrated body diode in the NMOS switch, TI highly recommends a  $C_{IN}$  greater than  $C_L$ . A  $C_L$  greater than  $C_{IN}$  can cause  $V_{OUT}$  to exceed  $V_{IN}$  when the system supply is removed. This event can result in current flow through the body diode from  $V_{OUT}$  to  $V_{IN}$ . TI recommends a  $C_{IN}$  to  $C_L$  ratio of 10 to 1 for minimizing  $V_{IN}$  dip caused by inrush currents during startup; however, a 10 to 1 ratio for capacitance is not required for proper functionality of the device. A ratio smaller than 10 to 1 (such as 1 to 1) can cause slightly more  $V_{IN}$  dip upon turn-on due to inrush currents. This event can be mitigated by increasing the capacitance on the CT pin for a longer rise time (see the *Adjustable Rise Time* section).

#### 10.1.5 $V_{IN}$ and $V_{BIAS}$ Voltage Range

For optimal  $R_{ON}$  performance, make sure  $V_{IN} \leq V_{BIAS}$ . The device is still functional if  $V_{IN} > V_{BIAS}$  but it exhibits  $R_{ON}$  greater than what is listed in the *Electrical Characteristics— $V_{BIAS} = 2\text{ V to } 2.5\text{ V}$*  table. See the following

figure for an example of a typical device. Notice the increasing  $R_{ON}$  as  $V_{IN}$  exceeds  $V_{BIAS}$  voltage. Be sure to never exceed the maximum voltage rating for  $V_{IN}$  and  $V_{BIAS}$ .

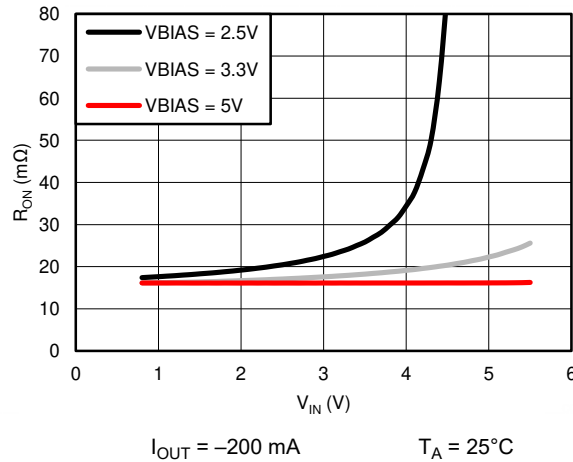

Figure 10-1.  $R_{ON}$  vs  $V_{IN}$  ( $V_{IN} > V_{BIAS}$ )

## 10.2 Typical Application

This application demonstrates how the TPS22965x-Q1 can be used to power downstream modules.

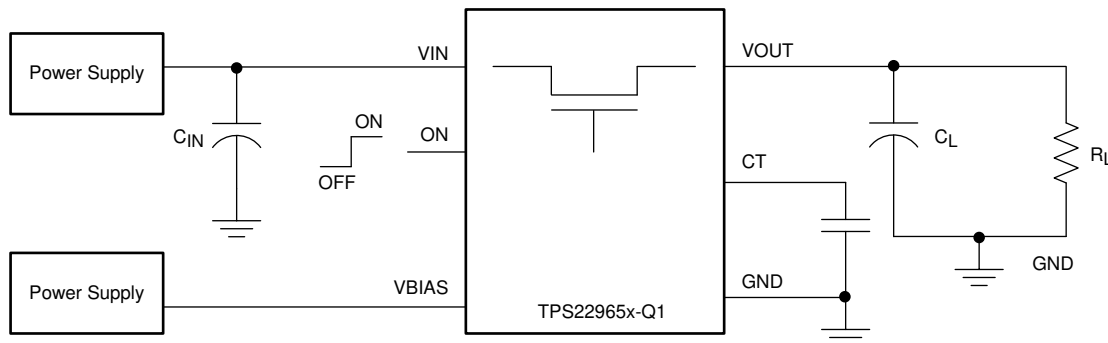

Figure 10-2. Schematic for Powering a Downstream Module

### 10.2.1 Design Requirements

Use the values listed in the following table as the design parameters.

Table 10-1. Design Parameters

| DESIGN PARAMETER                  | EXAMPLE VALUE    |
|-----------------------------------|------------------|
| $V_{IN}$                          | 3.3 V            |
| $V_{BIAS}$                        | 5 V              |
| $C_L$                             | 22 $\mu\text{F}$ |
| Maximum acceptable inrush current | 400 mA           |

## 10.2.2 Detailed Design Procedure

### 10.2.2.1 Inrush Current

When the switch is enabled, the output capacitors must be charged up from 0 V to the set value (3.3 V in this example). This charge arrives in the form of inrush current. Use the following equation to calculate inrush current.

$$\text{Inrush Current} = C \times dV/dt \tag{3}$$

where

- C = output capacitance
- dV = output voltage
- dt = rise time

The TPS22965x-Q1 offers adjustable rise time for VOUT. This feature allows the user to control the inrush current during turn-on. The appropriate rise time can be calculated using the design requirements and the inrush current equation. See [Equation 4](#) and [Equation 5](#).

$$400 \text{ mA} = 22 \text{ } \mu\text{F} \times 3.3 \text{ V} / dt \tag{4}$$

$$dt = 181.5 \text{ } \mu\text{s} \tag{5}$$

To ensure an inrush current of less than 400 mA, choose a CT value that yields a rise time of more than 181.5  $\mu\text{s}$ . See the oscilloscope captures in the [Application Curves](#) section for an example of how the CT capacitor can be used to reduce inrush current.

### 10.2.3 Application Curves

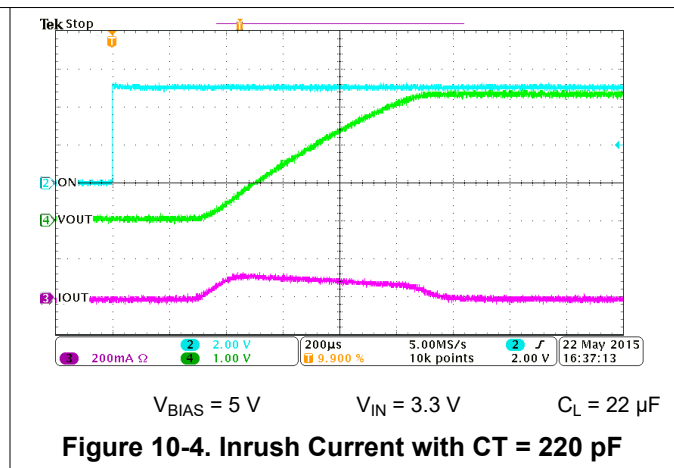
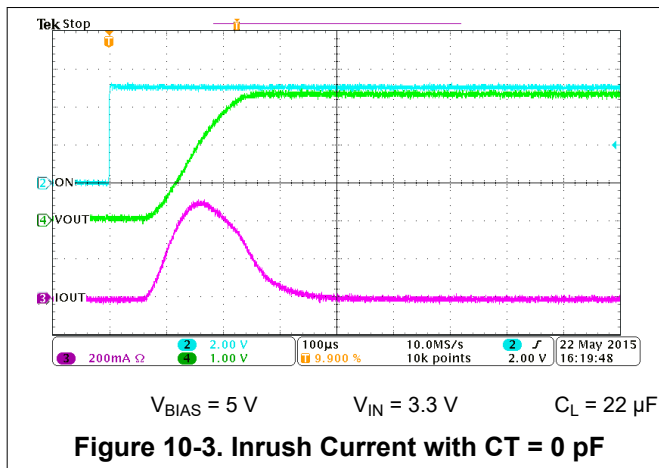

## 11 Power Supply Recommendations

The device is designed to operate from a VBIAS range of 2 V to 5.5 V and a VIN range of 0.8 V to VBIAS.

## 12 Layout

### 12.1 Layout Guidelines

For best performance, all traces must be as short as possible. To be most effective, the input and output capacitors must be placed close to the device to minimize the effects that parasitic trace inductances can have on normal operation. Using wide traces for VIN, VOUT, and GND helps minimize the parasitic electrical effects along with minimizing the case to ambient thermal impedance. The CT trace must be as short as possible to avoid parasitic capacitance.

### 12.2 Layout Example

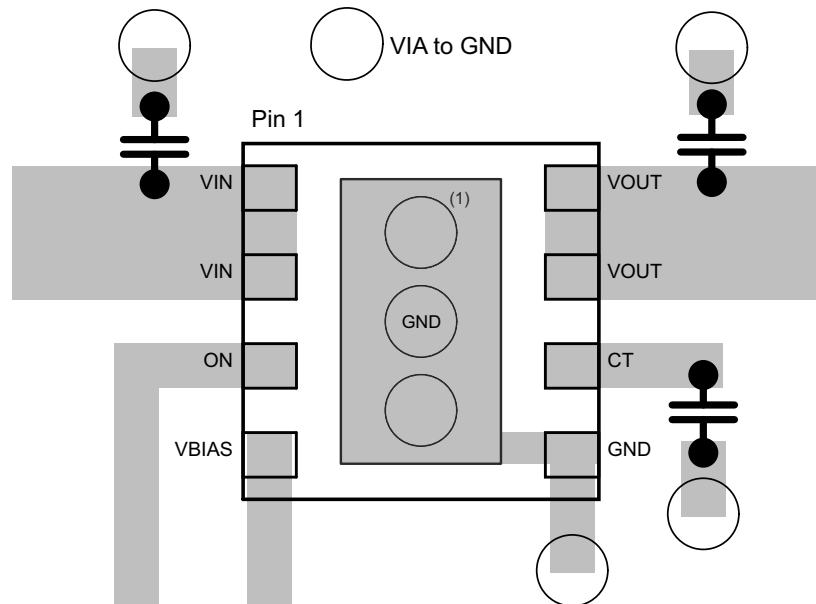

A. Thermal relief vias. Thermal relief vias connected to the exposed thermal pad.

**Figure 12-1. Layout Recommendation**

### 12.3 Thermal Consideration

The maximum IC junction temperature must be restricted to 150°C under normal operating conditions. Use the below equation as a guideline to calculate the maximum allowable dissipation,  $P_{D(max)}$ , for a given output current and ambient temperature.

$$P_{D(max)} = \frac{T_{J(max)} - T_A}{\theta_{JA}} \quad (6)$$

where

- $P_{D(max)}$  = maximum allowable power dissipation.
- $T_{J(max)}$  = maximum allowable junction temperature (150°C for the TPS22965x-Q1).
- $T_A$  = ambient temperature of the device.
- $\theta_{JA}$  = junction to air thermal impedance. See the [Thermal Information](#) table. This parameter is highly dependent upon board layout.

Refer to [Figure 12-1](#). Notice the thermal vias located under the exposed thermal pad of the device. The thermal vias allow for thermal diffusion away from the device.

## 13 Device and Documentation Support

### 13.1 Documentation Support

#### 13.1.1 Related Documentation

For related documentation see the following:

- Texas Instruments, [Load Switches: What Are They, Why Do You Need Them And How Do You Choose The Right One?](#) application note
- Texas Instruments, [Load Switch Thermal Considerations](#) application note
- Texas Instruments, [Managing Inrush Current](#) application note
- Texas Instruments, [TPS22965WDSGQ1EVM 5.7-V, 4-A, 16-mΩ On-Resistance Load Switch user's guide](#)

#### 13.2 Receiving Notification of Documentation Updates

To receive notification of documentation updates, navigate to the device product folder on [ti.com](#). Click on *Subscribe to updates* to register and receive a weekly digest of any product information that has changed. For change details, review the revision history included in any revised document.

#### 13.3 Support Resources

TI E2E™ [support forums](#) are an engineer's go-to source for fast, verified answers and design help — straight from the experts. Search existing answers or ask your own question to get the quick design help you need.

Linked content is provided "AS IS" by the respective contributors. They do not constitute TI specifications and do not necessarily reflect TI's views; see TI's [Terms of Use](#).

#### 13.4 Trademarks

TI E2E™ is a trademark of Texas Instruments.

All trademarks are the property of their respective owners.

#### 13.5 Electrostatic Discharge Caution



This integrated circuit can be damaged by ESD. Texas Instruments recommends that all integrated circuits be handled with appropriate precautions. Failure to observe proper handling and installation procedures can cause damage.

ESD damage can range from subtle performance degradation to complete device failure. Precision integrated circuits may be more susceptible to damage because very small parametric changes could cause the device not to meet its published specifications.

#### 13.6 Glossary

[TI Glossary](#) This glossary lists and explains terms, acronyms, and definitions.

## 14 Mechanical, Packaging, and Orderable Information

The following pages include mechanical, packaging, and orderable information. This information is the most-current data available for the designated devices. This data is subject to change without notice and without revision of this document. For browser-based versions of this data sheet, see the left-hand navigation pane.

**PACKAGING INFORMATION**

| Orderable Device  | Status<br>(1) | Package Type | Package Drawing | Pins | Package Qty | Eco Plan<br>(2) | Lead finish/<br>Ball material<br>(6) | MSL Peak Temp<br>(3) | Op Temp (°C) | Device Marking<br>(4/5) | Samples                 |
|-------------------|---------------|--------------|-----------------|------|-------------|-----------------|--------------------------------------|----------------------|--------------|-------------------------|-------------------------|
| TPS22965NQWDSGRQ1 | ACTIVE        | WSON         | DSG             | 8    | 3000        | RoHS & Green    | SN                                   | Level-2-260C-1 YEAR  | -40 to 125   | 11B                     | <a href="#">Samples</a> |
| TPS22965NQWDSGTQ1 | ACTIVE        | WSON         | DSG             | 8    | 250         | RoHS & Green    | SN                                   | Level-2-260C-1 YEAR  | -40 to 125   | 11B                     | <a href="#">Samples</a> |
| TPS22965NTDSGRQ1  | ACTIVE        | WSON         | DSG             | 8    | 3000        | RoHS & Green    | NIPDAU                               | Level-2-260C-1 YEAR  | -40 to 105   | ZDXI                    | <a href="#">Samples</a> |
| TPS22965QWDSGRQ1  | ACTIVE        | WSON         | DSG             | 8    | 3000        | RoHS & Green    | SN                                   | Level-2-260C-1 YEAR  | -40 to 125   | 11A                     | <a href="#">Samples</a> |
| TPS22965QWDSGTQ1  | ACTIVE        | WSON         | DSG             | 8    | 250         | RoHS & Green    | SN                                   | Level-2-260C-1 YEAR  | -40 to 125   | 11A                     | <a href="#">Samples</a> |
| TPS22965TDSGRQ1   | ACTIVE        | WSON         | DSG             | 8    | 3000        | RoHS & Green    | NIPDAU                               | Level-2-260C-1 YEAR  | -40 to 105   | ZYE                     | <a href="#">Samples</a> |
| TPS22965TDSGTQ1   | ACTIVE        | WSON         | DSG             | 8    | 250         | RoHS & Green    | NIPDAU                               | Level-2-260C-1 YEAR  | -40 to 105   | ZYE                     | <a href="#">Samples</a> |

(1) The marketing status values are defined as follows:

**ACTIVE:** Product device recommended for new designs.

**LIFEBUY:** TI has announced that the device will be discontinued, and a lifetime-buy period is in effect.

**NRND:** Not recommended for new designs. Device is in production to support existing customers, but TI does not recommend using this part in a new design.

**PREVIEW:** Device has been announced but is not in production. Samples may or may not be available.

**OBSELETE:** TI has discontinued the production of the device.

(2) **RoHS:** TI defines "RoHS" to mean semiconductor products that are compliant with the current EU RoHS requirements for all 10 RoHS substances, including the requirement that RoHS substance do not exceed 0.1% by weight in homogeneous materials. Where designed to be soldered at high temperatures, "RoHS" products are suitable for use in specified lead-free processes. TI may reference these types of products as "Pb-Free".

**RoHS Exempt:** TI defines "RoHS Exempt" to mean products that contain lead but are compliant with EU RoHS pursuant to a specific EU RoHS exemption.

**Green:** TI defines "Green" to mean the content of Chlorine (Cl) and Bromine (Br) based flame retardants meet JS709B low halogen requirements of <=1000ppm threshold. Antimony trioxide based flame retardants must also meet the <=1000ppm threshold requirement.

(3) MSL, Peak Temp. - The Moisture Sensitivity Level rating according to the JEDEC industry standard classifications, and peak solder temperature.

(4) There may be additional marking, which relates to the logo, the lot trace code information, or the environmental category on the device.

(5) Multiple Device Markings will be inside parentheses. Only one Device Marking contained in parentheses and separated by a "~" will appear on a device. If a line is indented then it is a continuation of the previous line and the two combined represent the entire Device Marking for that device.

<sup>(6)</sup> Lead finish/Ball material - Orderable Devices may have multiple material finish options. Finish options are separated by a vertical ruled line. Lead finish/Ball material values may wrap to two lines if the finish value exceeds the maximum column width.

**Important Information and Disclaimer:**The information provided on this page represents TI's knowledge and belief as of the date that it is provided. TI bases its knowledge and belief on information provided by third parties, and makes no representation or warranty as to the accuracy of such information. Efforts are underway to better integrate information from third parties. TI has taken and continues to take reasonable steps to provide representative and accurate information but may not have conducted destructive testing or chemical analysis on incoming materials and chemicals. TI and TI suppliers consider certain information to be proprietary, and thus CAS numbers and other limited information may not be available for release.

In no event shall TI's liability arising out of such information exceed the total purchase price of the TI part(s) at issue in this document sold by TI to Customer on an annual basis.

**OTHER QUALIFIED VERSIONS OF TPS22965-Q1 :**

- Catalog : [TPS22965](#)

NOTE: Qualified Version Definitions:

- Catalog - TI's standard catalog product



**TAPE AND REEL INFORMATION**

**QUADRANT ASSIGNMENTS FOR PIN 1 ORIENTATION IN TAPE**

\*All dimensions are nominal

| Device            | Package Type | Package Drawing | Pins | SPQ  | Reel Diameter (mm) | Reel Width W1 (mm) | A0 (mm) | B0 (mm) | K0 (mm) | P1 (mm) | W (mm) | Pin1 Quadrant |
|-------------------|--------------|-----------------|------|------|--------------------|--------------------|---------|---------|---------|---------|--------|---------------|
| TPS22965NQWDSGRQ1 | WSON         | DSG             | 8    | 3000 | 179.0              | 8.4                | 2.2     | 2.2     | 1.2     | 4.0     | 8.0    | Q2            |
| TPS22965NQWDSGTQ1 | WSON         | DSG             | 8    | 250  | 179.0              | 8.4                | 2.2     | 2.2     | 1.2     | 4.0     | 8.0    | Q2            |
| TPS22965NTDSGRQ1  | WSON         | DSG             | 8    | 3000 | 180.0              | 8.4                | 2.3     | 2.3     | 1.15    | 4.0     | 8.0    | Q2            |
| TPS22965QWDSGRQ1  | WSON         | DSG             | 8    | 3000 | 179.0              | 8.4                | 2.2     | 2.2     | 1.2     | 4.0     | 8.0    | Q2            |
| TPS22965QWDSGTQ1  | WSON         | DSG             | 8    | 250  | 179.0              | 8.4                | 2.2     | 2.2     | 1.2     | 4.0     | 8.0    | Q2            |
| TPS22965TDSGRQ1   | WSON         | DSG             | 8    | 3000 | 180.0              | 8.4                | 2.3     | 2.3     | 1.15    | 4.0     | 8.0    | Q2            |
| TPS22965TDSGTQ1   | WSON         | DSG             | 8    | 250  | 180.0              | 8.4                | 2.3     | 2.3     | 1.15    | 4.0     | 8.0    | Q2            |

**TAPE AND REEL BOX DIMENSIONS**

\*All dimensions are nominal

| Device            | Package Type | Package Drawing | Pins | SPQ  | Length (mm) | Width (mm) | Height (mm) |
|-------------------|--------------|-----------------|------|------|-------------|------------|-------------|
| TPS22965NQWDSGRQ1 | WSON         | DSG             | 8    | 3000 | 213.0       | 191.0      | 35.0        |
| TPS22965NQWDSGTQ1 | WSON         | DSG             | 8    | 250  | 213.0       | 191.0      | 35.0        |
| TPS22965NTDSGRQ1  | WSON         | DSG             | 8    | 3000 | 210.0       | 185.0      | 35.0        |
| TPS22965QWDSGRQ1  | WSON         | DSG             | 8    | 3000 | 213.0       | 191.0      | 35.0        |
| TPS22965QWDSGTQ1  | WSON         | DSG             | 8    | 250  | 213.0       | 191.0      | 35.0        |
| TPS22965TDSGRQ1   | WSON         | DSG             | 8    | 3000 | 210.0       | 185.0      | 35.0        |
| TPS22965TDSGTQ1   | WSON         | DSG             | 8    | 250  | 210.0       | 185.0      | 35.0        |

## GENERIC PACKAGE VIEW

**DSG 8**

**WSON - 0.8 mm max height**

2 x 2, 0.5 mm pitch

PLASTIC SMALL OUTLINE - NO LEAD

This image is a representation of the package family, actual package may vary.  
Refer to the product data sheet for package details.

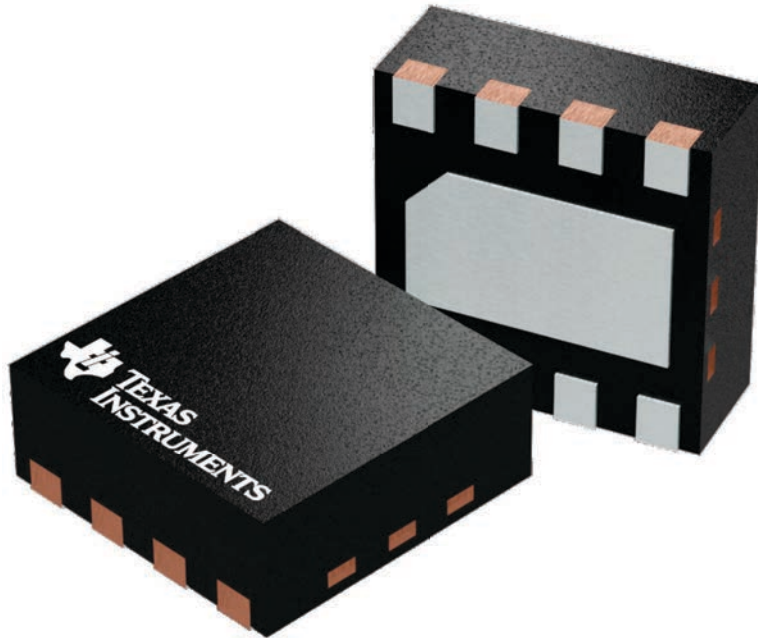

4224783/A

# DSG0008B

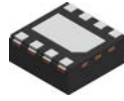

# PACKAGE OUTLINE

## WSON - 0.8 mm max height

PLASTIC SMALL OUTLINE - NO LEAD

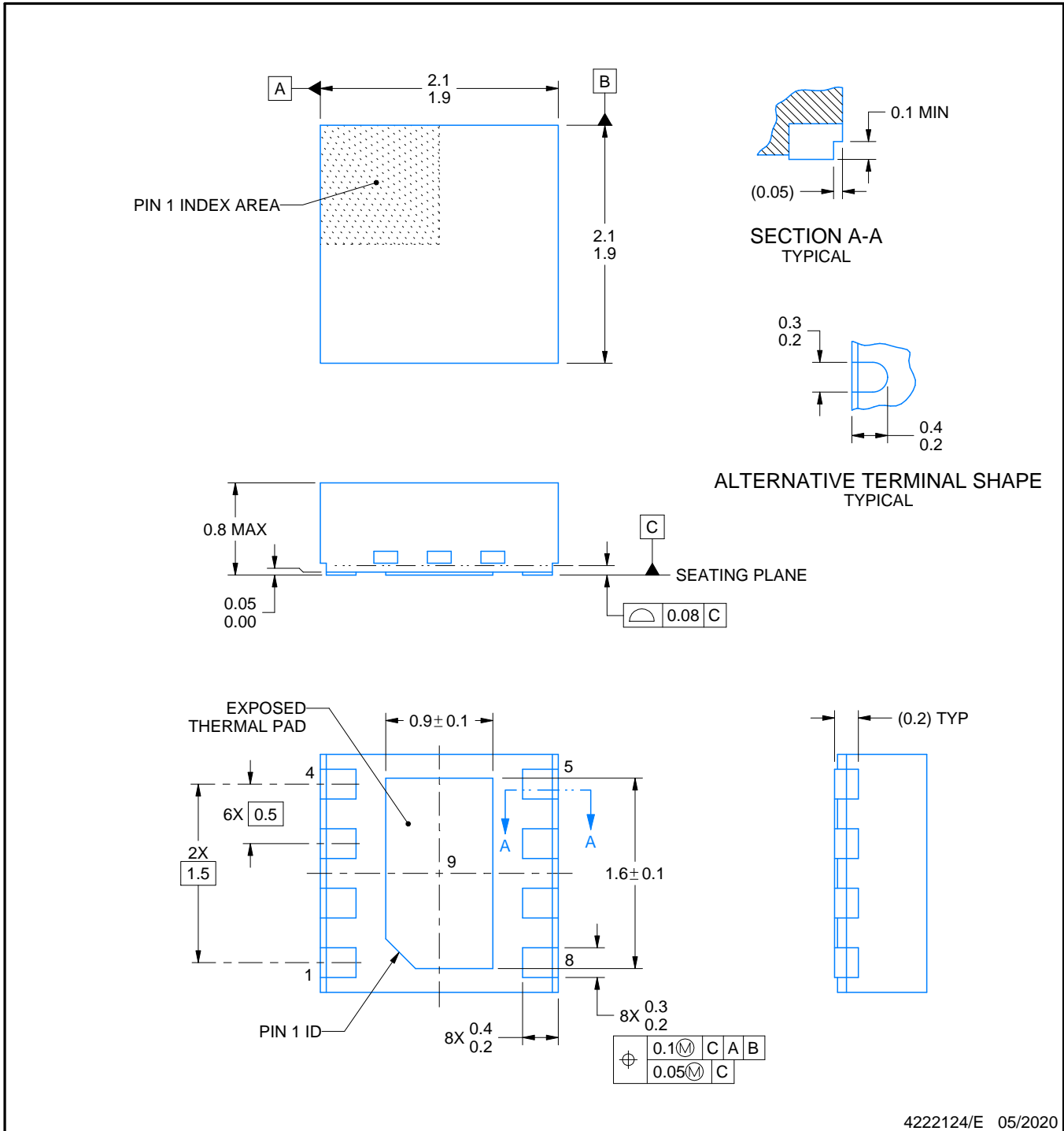

**NOTES:**

1. All linear dimensions are in millimeters. Any dimensions in parenthesis are for reference only. Dimensioning and tolerancing per ASME Y14.5M.
2. This drawing is subject to change without notice.
3. The package thermal pad must be soldered to the printed circuit board for thermal and mechanical performance.



# EXAMPLE STENCIL DESIGN

DSG0008B

WSON - 0.8 mm max height

PLASTIC SMALL OUTLINE - NO LEAD

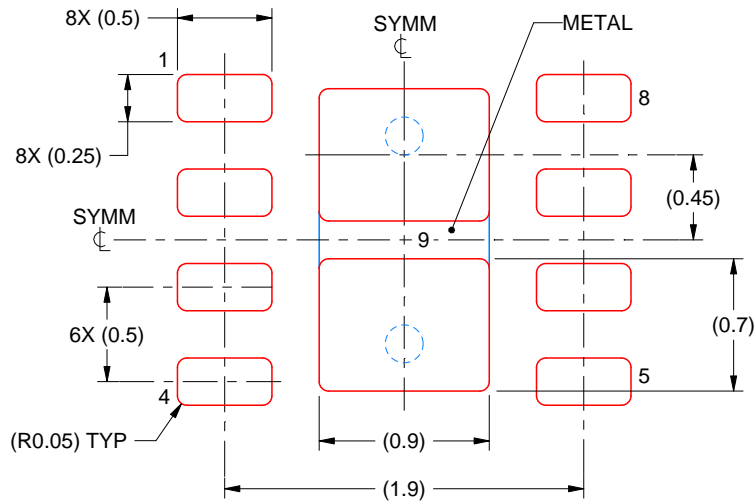

SOLDER PASTE EXAMPLE  
BASED ON 0.125 mm THICK STENCIL

EXPOSED PAD 9:  
87% PRINTED SOLDER COVERAGE BY AREA UNDER PACKAGE  
SCALE:25X

4222124/E 05/2020

NOTES: (continued)

6. Laser cutting apertures with trapezoidal walls and rounded corners may offer better paste release. IPC-7525 may have alternate design recommendations.

# DSG0008A

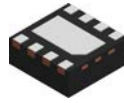

# PACKAGE OUTLINE

## WSON - 0.8 mm max height

PLASTIC SMALL OUTLINE - NO LEAD

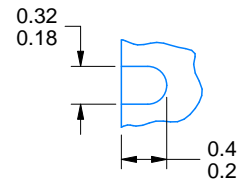
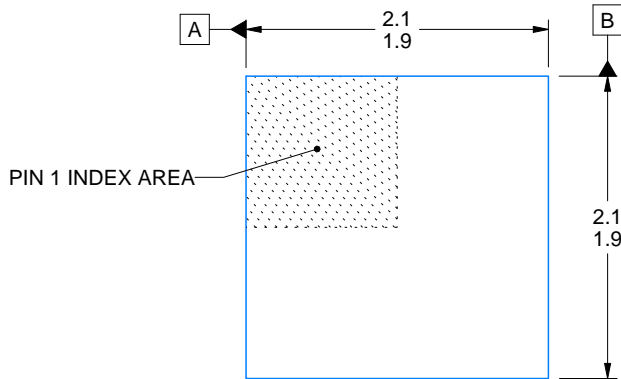

ALTERNATIVE TERMINAL SHAPE TYPICAL

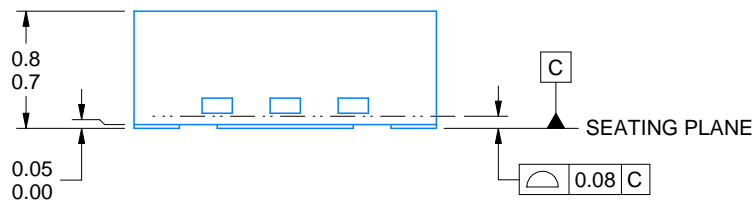

| SIDE WALL METAL THICKNESS DIM A |          |
|---------------------------------|----------|
| OPTION 1                        | OPTION 2 |
| 0.1                             | 0.2      |

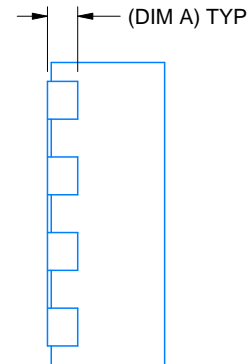
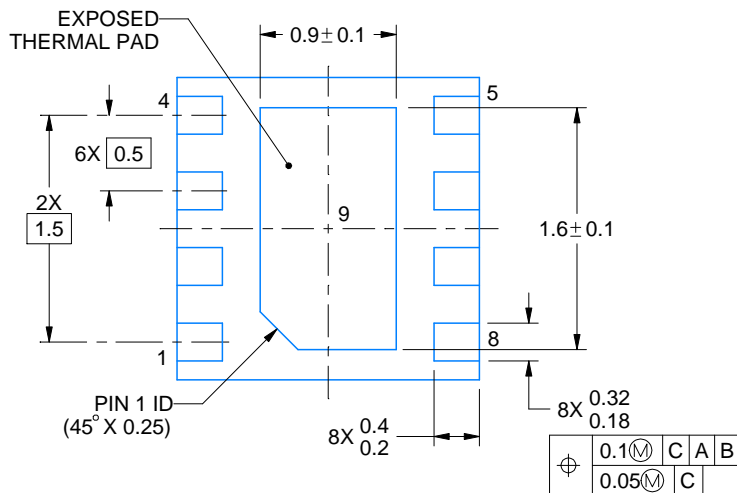

4218900/E 08/2022

### NOTES:

1. All linear dimensions are in millimeters. Any dimensions in parenthesis are for reference only. Dimensioning and tolerancing per ASME Y14.5M.
2. This drawing is subject to change without notice.
3. The package thermal pad must be soldered to the printed circuit board for thermal and mechanical performance.







## IMPORTANT NOTICE AND DISCLAIMER

TI PROVIDES TECHNICAL AND RELIABILITY DATA (INCLUDING DATA SHEETS), DESIGN RESOURCES (INCLUDING REFERENCE DESIGNS), APPLICATION OR OTHER DESIGN ADVICE, WEB TOOLS, SAFETY INFORMATION, AND OTHER RESOURCES "AS IS" AND WITH ALL FAULTS, AND DISCLAIMS ALL WARRANTIES, EXPRESS AND IMPLIED, INCLUDING WITHOUT LIMITATION ANY IMPLIED WARRANTIES OF MERCHANTABILITY, FITNESS FOR A PARTICULAR PURPOSE OR NON-INFRINGEMENT OF THIRD PARTY INTELLECTUAL PROPERTY RIGHTS.

These resources are intended for skilled developers designing with TI products. You are solely responsible for (1) selecting the appropriate TI products for your application, (2) designing, validating and testing your application, and (3) ensuring your application meets applicable standards, and any other safety, security, regulatory or other requirements.

These resources are subject to change without notice. TI grants you permission to use these resources only for development of an application that uses the TI products described in the resource. Other reproduction and display of these resources is prohibited. No license is granted to any other TI intellectual property right or to any third party intellectual property right. TI disclaims responsibility for, and you will fully indemnify TI and its representatives against, any claims, damages, costs, losses, and liabilities arising out of your use of these resources.

TI's products are provided subject to [TI's Terms of Sale](#) or other applicable terms available either on [ti.com](http://ti.com) or provided in conjunction with such TI products. TI's provision of these resources does not expand or otherwise alter TI's applicable warranties or warranty disclaimers for TI products.

TI objects to and rejects any additional or different terms you may have proposed.

Mailing Address: Texas Instruments, Post Office Box 655303, Dallas, Texas 75265  
Copyright © 2022, Texas Instruments Incorporated