

Products marked  are discontinued as of August 31, 2011

 Certified AQ2A2-ZP3/28VDC, AQ2A2-J-ZP3/28VDC, AQ3A2-ZP3/28VDC, AQ1AD2-3/28VDC and AQ2AD1-3/28VDC

 Certified AQ2A2-ZP3/28VDC, AQ2A2-J-ZP3/28VDC, AQ3A2-ZP3/28VDC, AQ1AD2-3/28VDC and AQ2AD1-3/28VDC

Please contact us about TUV certified products.

 Certified AQ2A2-ZP3/28VDC, AQ2A2-J-ZP3/28VDC, AQ3A2-ZP3/28VDC, AQ1AD2-3/28VDC and AQ2AD1-3/28VDC

 Certified AQ3A2-ZT4/32VDC, AQ3A2-J-ZT4/32VDC and AQ10A2-ZT4/32VDC

Panasonic
ideas for life

1A to 10A high-capacity
PC board terminal type
solid state relay

AQ1 RELAYS

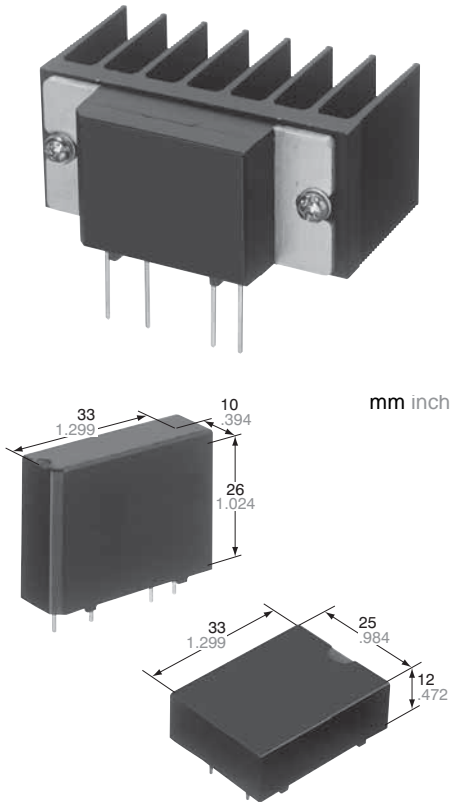

 AC optically coupled isolation type products to be discontinued.

FEATURES

1. 10A high-capacity realized for PC board terminal (with heat sink)

SSR for compact PC boards with 10 A capacity that is two times greater than our previous model. It is suitable for long-life, highly frequent control.

2. VDE (EN60950-1) reinforced insulation compliant

Fully satisfies demand for safety by guaranteeing compliance with EN60950-1 safety standard and featuring 3,000 V reinforced insulation (AQ3A2-ZT4/32VDC, AQ3A2-J-ZT4/32VDC and AQ10A2-ZT4/32VDC).

3. Superior anti-vibration and anti-shock characteristics

The body is molded as a single unit with flame resistant resin which makes it highly resistant against vibration and shock, and gives it superior protection from environment. The body can also be washed.

4. Vertical types with SIL terminal arrangement and flat types are available.

1) The vertical type is available in thicknesses of 10 mm (2 A and 3 A types) and 12 mm (5 A and 10 A types).

Terminal arrangement is SIL in integral multiples of 2.54 mm (0.1 inch).

2) The height of the flat type is 12 mm.

The terminal arrangement is DIL in integral multiples of 2.54 mm.

5. Reduced noise generation

The load will operate at close to zero voltage even when the input signal is applied during a cycle. Also, even if an input signal is cancelled during a cycle, the load is cut off at close to zero current.

For this reason, hardly any noise is produced and radio frequency interference (RFI) and electromagnetic interference (EMI) are kept to a minimum.

6. Built-in Snubber circuit prevents malfunction.



TYPICAL APPLICATIONS

- Printing machines
- Packing machines
- Traffic signal control
- Automatic ticket punchers
- Terminal equipment of data processing
- Computer peripherals
- NC machines

TYPES

1. AQ1 Solid State Relays

Standard packing: Carton 20 pcs., Case 200 pcs.

Load	Isolation	Zero-cross function	Type	Input voltage	Load current Load voltage	Part No.
AC	Phototriac coupler	Zero-cross*1	3 A (Vertical)	4 to 32 V DC	3 A, 75 to 250 V AC	AQ3A2-ZT4/32VDC
			3 A (flat)	4 to 32 V DC	3 A, 75 to 250 V AC	AQ3A2-J-ZT4/32VDC
			10 A	4 to 32 V DC	10 A, 75 to 250 V AC (5 A without heat sink)	AQ10A2-ZT4/32VDC
AC	Optically coupled isolation	Zero-cross	2 A (Vertical)	3 to 28 V DC	2 A, 75 to 250 V AC	 AQ2A2-ZP3/28VDC
			2 A (flat)	3 to 28 V DC	2 A, 75 to 250 V AC	 AQ2A2-J-ZP3/28VDC
			5 A	3 to 28 V DC	5 A, 75 to 250 V AC (3 A without heat sink)	 AQ5A2-ZP3/28VDC
DC	Optically coupled isolation	-	1 A	3 to 28 V DC	1 A, 10 to 200 V DC	AQ1AD2-3/28VDC
			2 A	3 to 28 V DC	2 A, 3 to 60 V DC	AQ2AD1-3/28VDC

Note: *1 Non zero-cross type also available. Please inquire.

2. Heat sink for AQ1 solid state relay

Standard packing: Carton 20 pcs., Case 200 pcs.

Product name	Part No.
Heat sink for AQ5A2-ZP3/28VDC and AQ10A2-ZT4/32VDC	AQ-HS-5A

ORDERING INFORMATION

	AQ	2A	2	J	ZP	3/28 VDC	
Load current	Load voltage		Shape		Type		Input voltage
1 A 2 A 3 A 5 A 10 A	2: 75 to 250 V AC D1: 3 to 60 V DC D2: 10 to 200 V DC		Nil: Vertical type J: Flat type		Nil: DC output ZP: Zero-cross AC output (Photocoupler) ZT: Zero-cross AC output (Phototriac coupler)		3/28 V DC: 3 to 28 V DC 4/32 V DC: 4 to 32 V DC

* Random types are available upon request.

SPECIFICATIONS

1. Rating (at 20°C 68°F, Ripple factor: less than 1%)

Item	Type	AC output type				DC output type		Remarks
		Zero-cross				1 A type	2 A type	
		3 A type	10 A type	2 A type	5 A type			
Input side	Input voltage	4 to 32 V DC		3 to 28 V DC		3 to 28 V DC		
	Input impedance	—		Approx. 1.6 kΩ (3 to 28 V DC)		Approx. 1.6 kΩ (3 to 28 V DC)		
	Input current, max.	20 mA		—		—		
	Drop-out voltage, min.	1.0 V		0.8 V		0.8 V		
Load side	Max. load current	3 A	10 A* ¹	2 A	5 A* ²	1 A	2 A	Refer to "REFERENCE DATA 1. Load current vs. ambient temperature characteristics".
	Load voltage	75 to 250 V AC				10 to 200 V DC	3 to 60 V DC	
	Non-repetitive surge current	100 A		80 A	100 A	5 A (1 s)		AC: In one cycle at 60 Hz, DC: 1s
	Max. "OFF-state" leakage current	5 mA				1 mA		AC: at 200 V, 60Hz DC: When maximum load voltage is applied.
	Max. "ON-state" voltage drop	1.6 V				1.6 V	2.3 V	At Max. carrying current
	Min. load current	50 mA* ³				5 mA* ³		

Notes: *1 When heat sink (AQ-HS-5A) is installed. The max. load current is 5 A when heat sink is not installed.

*2 When heat sink (AQ-HS-5A) is installed. The max. load current is 3 A when heat sink is not installed.

*3 When load current is below the rating, refer to "Cautions for Use".

2. Characteristics (at 20°C 68°F, Ripple factor: less than 1%)

Item	Type	AC output				DC output	Remarks
		Zero-cross					
		3 A type	10 A type	2 A type	5 A type		
Operate time, Max.		(1/2 cycle of voltage sine wave) + 1 ms				0.5 ms	
Release time, Max.		(1/2 cycle of voltage sine wave) + 1 ms				2 ms	
Insulation resistance, Min.		100 M Ω for input, output and case				100 M Ω for input, output	at 500 V DC
Breakdown voltage		4,000 Vrms between input and output 2,500 Vrms among input, output and case		3,000 Vrms between input and output	3,000 Vrms between input and output 1,500 Vrms among input, output and case	3,000 Vrms between input-output	For 1 minute
Vibration resistance	Destructive	117.6 m/s ² {12G}, 10 to 55 Hz at double amplitude of 2 mm				117.6 m/s ² {12G}, 10 to 55 Hz at double amplitude of 2 mm	1 hour for X, Y, Z axis
	Functional	117.6 m/s ² {12G}, 10 to 55 Hz at double amplitude of 2 mm				117.6 m/s ² {12G}, 10 to 55 Hz at double amplitude of 2 mm	10 minutes for X, Y, Z axis
Shock resistance	Destructive	Min. 980 m/s ² {100 G}				Min. 980 m/s ² {100 G}	5 times each for X, Y, Z axis
	Functional	Min. 980 m/s ² {100 G}				Min. 980 m/s ² {100 G}	4 times each for X, Y, Z axis
Ambient temperature		-30°C to +80°C -22°F to +176°F					
Storage temperature		-30°C to +100°C -22°F to +212°F					
Operational method		Zero-cross (Turn-ON and Turn-OFF)				—	

DIMENSIONS (mm inch)

Download [CAD Data](#) from our Web site.

1. AC output, 2A and 3A types (Vertical)

[CAD Data](#)

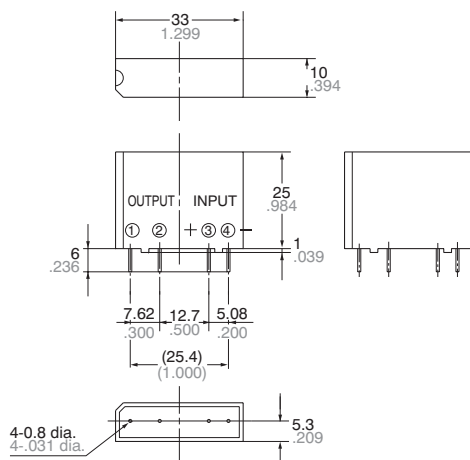

General tolerance: $\pm 0.5 \pm .020$

Mounting hole location (Copper-side view)

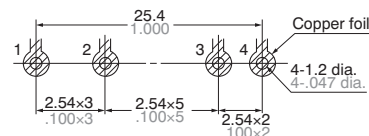

Schematic

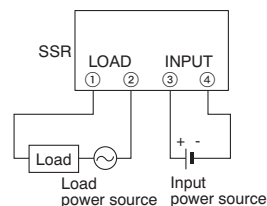

Tolerance: $\pm 0.1 \pm .004$

2. AC output, 2A and 3A types (Flat)

[CAD Data](#)

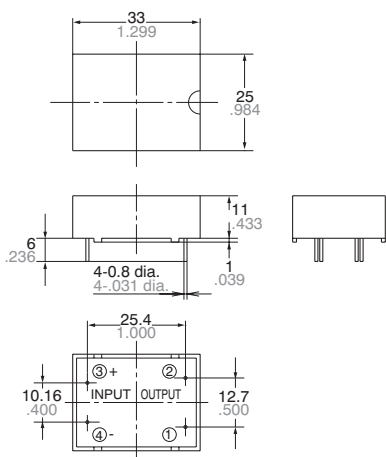
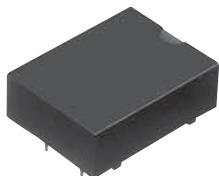

General tolerance: $\pm 0.5 \pm .020$

Mounting hole location (Copper-side view)

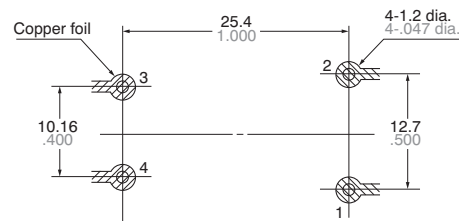

Schematic

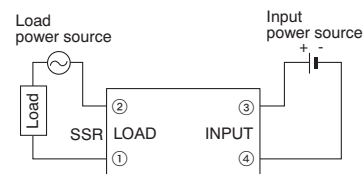

Tolerance: $\pm 0.1 \pm .004$

3. AC output, 5A and 10A types

[CAD Data](#)

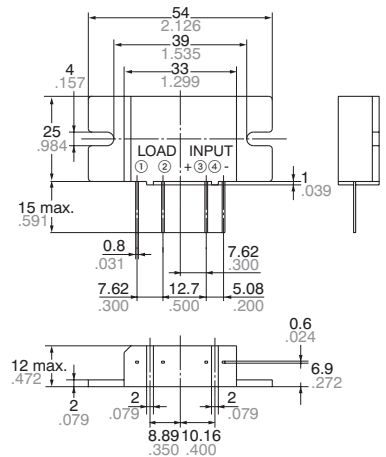
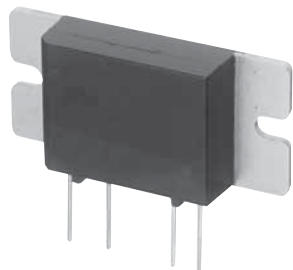

General tolerance: $\pm 0.5 \pm .020$

Mounting hole location (Copper-side view)

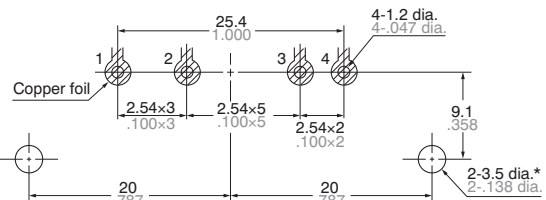

* There 2 holes are not necessary when not using heat sink (AQ-HS-5A)

Schematic

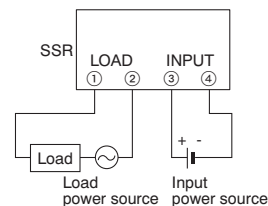

Tolerance: $\pm 0.1 \pm .004$

4. Heat sink (for AQ10A2-ZT4/32VDC and AQ5A2-ZP3/28VDC)

mm inch

[CAD Data](#)

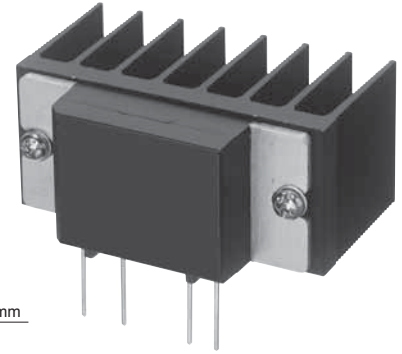
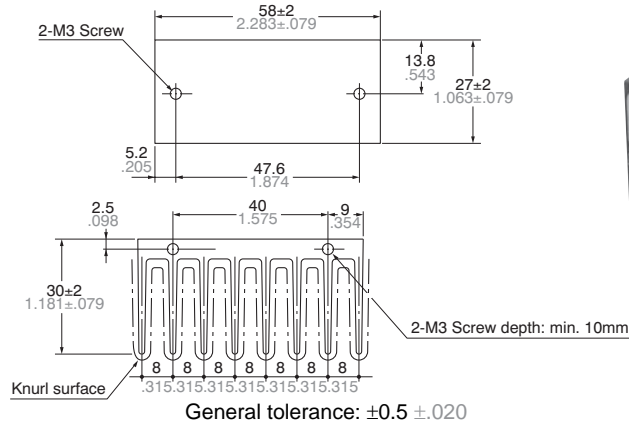

Heat sink attached to AQ1 relay

Note: When using heat sink, please refer to "Thermal Design"

5. DC output, 1A and 2A types

[CAD Data](#)

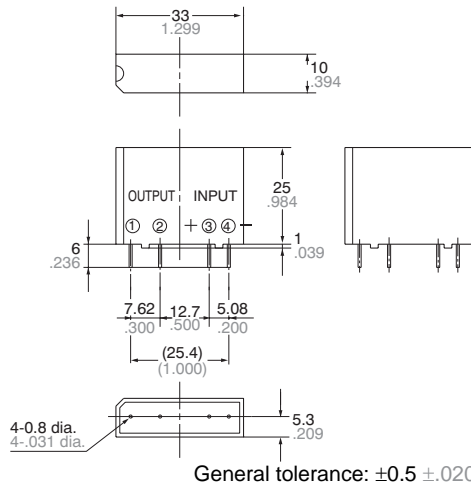

Mounting hole location (Copper-side view)

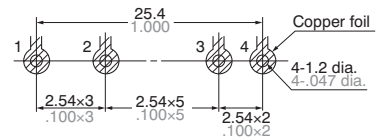

Schematic

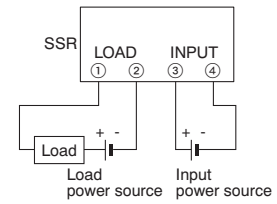

Tolerance: ±0.1 ±.004

REFERENCE DATA

1-(1) Load current vs. ambient temperature (AC output, 3 A type) Part No.: AQ3A2-ZT4/32VDC and AQ3A2-J-ZT4/32VDC
Allowable ambient temperature: -30°C to +80°C -22°F to +176°F

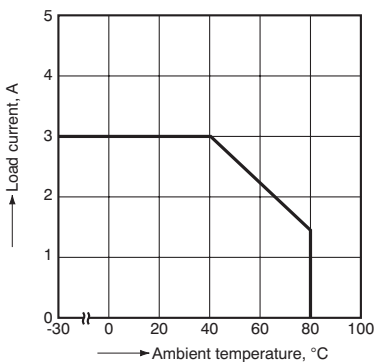

1-(2) Load current vs. ambient temperature (AC output, 10 A type) Part No.: AQ10A2-ZT4/32VDC
(A) When not using a heat sink
(B) When using a standard heat sink AQ-HS-5A
(When attached to a heat sink, use a heat conductive compound (Ex. Toshiba silicone YG6111 or TSK5303) of similar coating to improve cooling.)

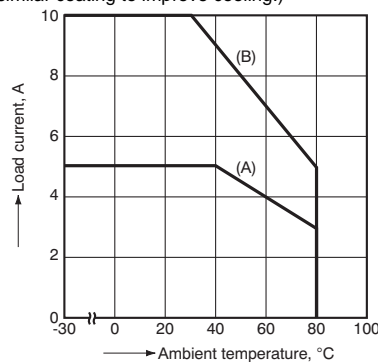

1-(3) Load current vs. ambient temperature (AC output, 2 A type) Part No.: AQ2A2-ZP3/28VDC and AQ2A2-J-ZP3/28VDC
Allowable ambient temperature: -30°C to +80°C -22°F to +176°F

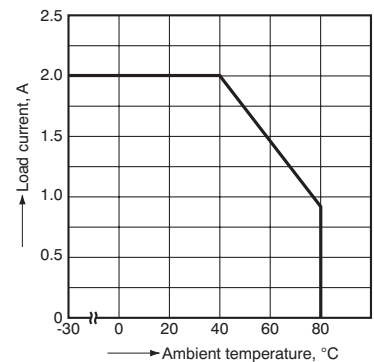

Products marked  are discontinued as of August 31, 2011

1.-(4) Load current vs. ambient temperature
 (AC output, 5 A type) Part No.: AQ5A2-ZP3/28VDC
 (A) When not using a heat sink
 (B) When using a standard heat sink AQ-HS-5A
 (When attached to a heat sink, use a heat conductive compound (Ex. Toshiba silicone YG6111 or TSK5303) of similar coating to improve cooling.)

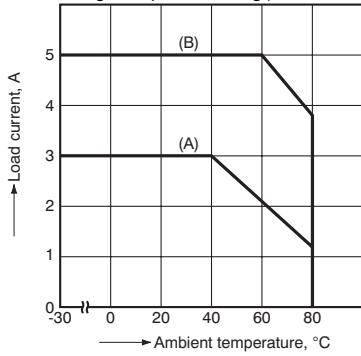

1.-(5) Load current vs. ambient temperature
 (DC output, 1 A and 2 A types) Part No.: AQ1AD2-3/28VDC and AQ2AD1-3/28VDC
 Allowable ambient temperature:
 -30°C to +80°C -22°F to +176°F

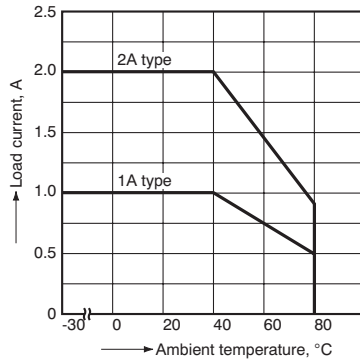

2.-(1) Non-repetitive surge current vs. carrying time
 (AC output, 3 A and 10 A types)
 Part No.: AQ3A2-ZT4/32VDC, AQ3A2-J-ZT4/32VDC and AQ10A2-ZT4/32VDC

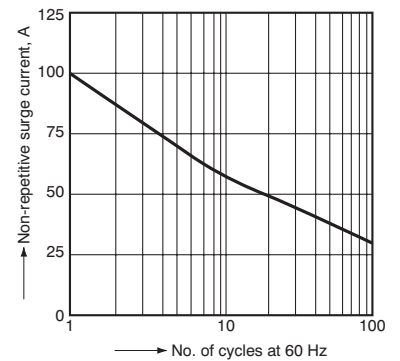

2.-(2) Non-repetitive surge current vs. carrying time
 (AC output, 2 A type) Part No.: AQ2A2-ZP3/28VDC and AQ2A2-J-ZP3/28VDC

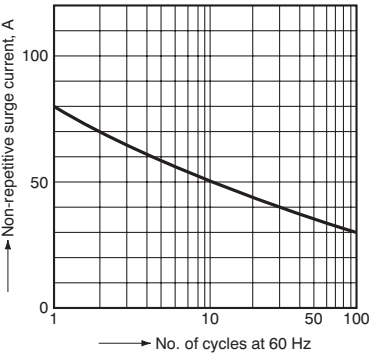

2.-(3) Non-repetitive surge current vs. carrying time
 (AC output, 5 A type) Part No.: AQ5A2-ZP3/28VDC

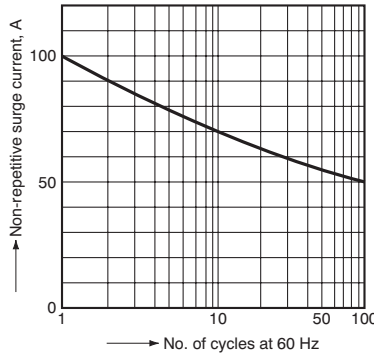

2.-(4) Non-repetitive surge current vs. carrying time
 (DC output) Part No.: AQ1AD2-3/28VDC and AQ2AD1-3/28VDC

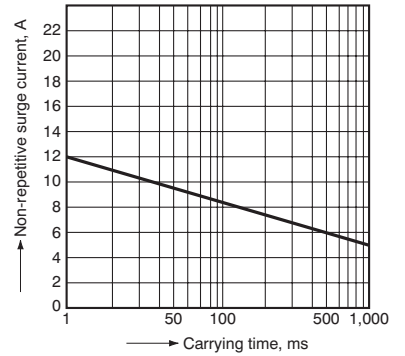

3.-(1) Input current vs. input voltage characteristics
 (AC output, 3 A and 10 A types)
 Part No.: AQ3A2-ZT4/32VDC, AQ3A2-J-ZT4/32VDC and AQ10A2-ZT4/32VDC

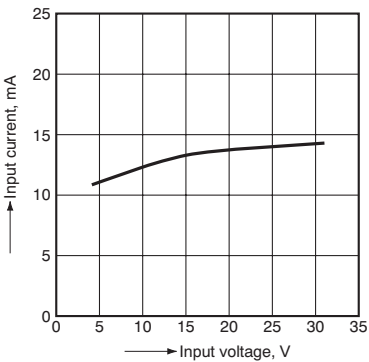

3.-(2) Input current vs. input voltage characteristics
 (AC output, 2 A and 5 A types)
 Part No.: AQ2A2-ZP3/28VDC, AQ2A2-J-ZP3/28VDC and AQ5A2-ZP3/28VDC
 (DC output)
 Part No.: AQ1AD2-3/28VDC and AQ2AD1-3/28VDC

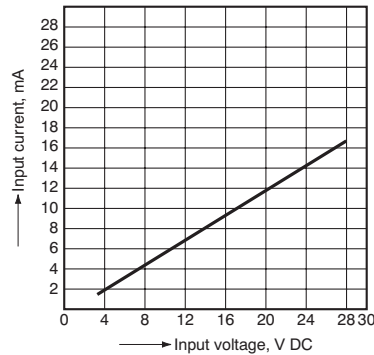

CAUTIONS FOR USE

1. Input side

1) Noise and surge protection at the input side

A high noise surge voltage applied to the SSR input circuit can cause malfunction or permanent damage to the device. If such a high surge is anticipated, use C or R noise absorber in the input circuit.

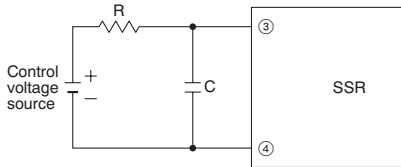

2) When the input terminals are connected with reverse polarity
Reversing the polarity will not cause damage to the device, due to the presence of a protection diode, but the device will not operate.

3) In the case of operating voltage containing ripple

If the SSR control voltage contains ripple, the peak of the ripple should not exceed the maximum rated control voltage "32V", and the bottom of the ripple should exceed the minimum rated control voltage "4V".

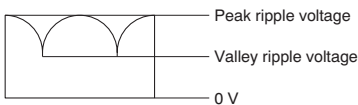

2. Output side

1) Regarding output noise surge protection

A high noise surge voltage applied to the SSR load circuit can cause malfunction or permanent damage to the device. If such a high surge is anticipated, use a varistor across the SSR output.

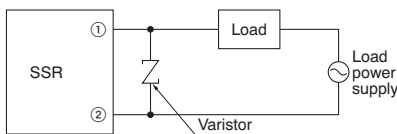

Keep the varistor voltage to no more than 500 V.

2) When used for the load less than rated
An SSR may malfunction if it is used below the specified load. In such an event, use a dummy resistor in parallel with the load.

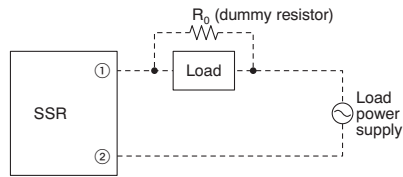

Set a value of dummy resistor so that the load current becomes 50 mA or greater due to the dummy resistor and load.

3. When using bent output terminals

To avoid applying mechanical stress on the main unit and molded section of the solid state relay, radio pliers should be used to grasp the terminals between the point of bending and the molded case when making the bends.

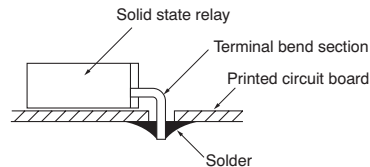

4. When a heat sink is mounted on the 5 A or 10 A type

The heat sink (AQ-HS-5A) or a radiator which can make good contact should be used.

If a heat sink is used in which the contact condition is bad, a heat conducting compound should be used to improve the heat radiation. (Ex. Silicon compound Toshiba silicon YG6111 or TSK5303) The compound should be applied between the heat sink and the AQ1.

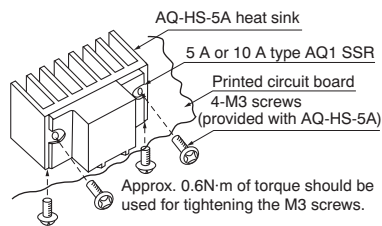

5. Others

1) If an SSR is used in close proximity to another SSR or heat-generating device, its ambient temperature may exceed the allowable level. Carefully plan SSR layout and ventilation.

2) Soldering to SSR terminals should be completed within 5 seconds at 260°C 500°F.

3) Terminal connections should be made by referring to the associated wiring diagram.

4) For higher reliability, check device quality under actual operating conditions.

6. Transportation and storage

1) Extreme vibration during transport will warp the lead or damage the relay. Handle the outer and inner boxes with care.

2) Storage under extreme conditions will cause soldering degradation, external appearance defects, and deterioration of the characteristics. The following storage conditions are recommended:

- Temperature: 5 to 30°C 41 to 86°F
- Humidity: Less than 60% R.H.
- Atmosphere: No harmful gasses such as sulfurous acid gas, minimal dust.

Cautions for Use